

2022 CASES WORKBOOK

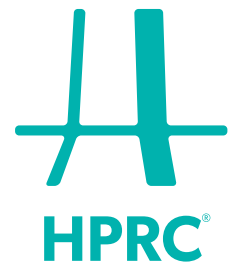



### **Our Brand**

We're about happiness by cases. It means we're not just in the business of creating protective cases, even though that is what we do. Our everyday commitment is designed to make people happy.

From an ever-growing collection of innovative products to our passionate team who makes it happen, it's all about happiness.

### **Our Products**

We're always looking for what's next. We're constantly innovating our original designed form and function, proving a fresh approach to the art of cases. By incorporating different styles, top quality materials and eye-catching patterns into our design, we make more than a case. We make a statement.

### **Our History**

HPRC cases were born in 2006 with one simple premise: we can design a better case. In almost 15 years HPRC has grown into a successful international business, teaming up with important companies and partners. Our products can be found in 76 countries and have garnered top awards and praise. As we grow, our entrepreneurial spirit continues to drive the HPRC culture. After all, it's what helped us build one of the world's best hard cases brand.



# Inside the R-Evolution

Revolution begins inside first: we start every day thinking different, exploring new ideas, projects and solutions. We work side by side in Italy, but we turn to people all around the world to inspire and get inspired.

We are involved in a constant revolution that goes hand in hand with the spirit of renewal of the brand. Our day-to-day commitment is to meet customer needs and personalize their journey. To do better, to offer the best.



# Blue Bassano: new color, the best of us

Different color, new logo, refreshed style, best materials and services to look at the future.

Same quality and warranty provided.

**HPRC** is synonymous of change: a sense of urgency around the need of **R-Evolution**.

# Ultralight. Watertight. Smart Cases.

HPRC cases can be used for all sorts of applications and different areas: photography, industrial, military, nautical, police and many others. HPRC provides total protection to the carried equipment against dust, water, impacts and corrosion caused by chemical agents.



Outdoor | Diving | Marine



Imaging & Broadcasting





Industrial | Electronic | It



Military | Government



Fire | Emergency | Medical

Photo by Flavio Oliva

# Highlights

## STRUCTURAL AND VISUAL UPGRADING



**New mechanics and engineering** of the short sides which provide more resistance to the shell, greater light-weight and improved flexibility.



**Refresh of the external surface** with a wrinkle effect to the smoothed parts. A new professional and essential design which upgrades the aesthetic while improving the mechanical properties of the shell.



**New Name Plate:** larger in dimensions, more shock-resistant and refreshed in design.

## ALL TERRAIN WHEELS SYSTEM



- cutting-edge innovation for a great grip
- use in any area and different weather conditions, ensuring versatility
- high performance in wet and dry conditions
- sure-footedness in a wide range of fields (asphalt, sand, stones, snow, porphyry)
- rolls smoothly for hundreds of miles
- more stability and enhanced safety
- easy wheels replacement
- increased wheels durability





## DRYKEEPER

### Protect your gear from moisture

Dry Keeper is a special container designed to protect your items from mildew, deterioration and damages caused by high humidity. The orange spherical Silica Gel is composed of a naturally occurring mineral silicon dioxide that is purified and processed into a beaded form. Silica Gel has a high absorption capacity and will remove moisture at temperatures as high as 150° F (65°C). Fits all cases.



## LIZARD PATT

### A revolutionary ergonomic handle, made of PP and SEBS material, which provides:

- high quality and secure grip, even in low temperatures and wet conditions
- no-slip for better control and safety, also in the presence of oils, grease and liquids
- greater level of comfort
- optimal handling
- scratch protection
- strengthened resistance
- long durability



## SERVICES



Custom Laser Design

### Custom Laser Design

HPRC CUSTOM LASER DESIGN is the new HPRC service born to offer endless possibilities to customize and add value to your case. No minimum order quantity. Technical support, graphic development and fast turnaround.



Business Solution

### Professional Custom Cases Solution

Our staff is passionate about developing high-quality tailor-made solutions to meet all your requirements.

THE FOAM COMPANY  
BASSANO

### The Foam Factory

Custom-designed foam inserts, no minimum quantity required.

# Commitments

## Our Commitments to you:

**1.UNDERSTAND** the problems of your market and your specific requirements. Through our expert knowledge of technological and economic trends we can offer an uncompromisingly individual approach to each customer.

**2.FIND** a transport solution tailored to your requirements. Our extensive cases range, our custom solutions that go far beyond our product offer, our team that assists you in selecting the case that is best suited to your own needs, are our core strengths.

**3.LISTEN** to and take account of your comments, through our network of experts and our frequent satisfaction surveys.

**4.BE** incessantly innovative and competitive in the professional cases market.

# HPRC: innovation, technology and design.

Most of hard watertight cases are made in standard pp: our r&d department has developed an enhanced compound, still based on pp, now balanced with additional high performance resins. Ttx01® allows to produce cases which are lighter in weight and stronger in robustness. The special mix we added makes the HPRC shell thinner and more elastic, increasing therefore the shockproof degree and the lightweight. On the top of that, maintaining pp characteristics, HPRC cases are acidproof, scratchproof, able to resist to extreme weather conditions and temperature changes (all products are tested from - 40° c up to 80°c).

Do you want to know more? Please contact our technical team: [tech@hprc.it](mailto:tech@hprc.it)



Body: TTX01® hardware: steel



Wheels: PA66+TPU



Handle: PP+SEBS  
Automatic Purge Valve



Extensible handle: ALU + SEBS



Latches: PA + GF



Internal O-ring. Made of EPDM



**HPRC life time warranty:** HPRC products have been built to rigorous standards of quality and are guaranteed against all defects in materials and workmanship for the whole life of the case.



**Airex** is the automatic purge valve that is auto press release adjusted to changing environments automatically.

The attention and respect toward the environment and the commitment to an eco-sustainable future are important values for HPRC

Our commitment starts from the design phase of the product, and involves all the production stages including the management of the impact of the product's end of life. All shells and components of HPRC cases are 100% recyclable: the production and transformation discards are indeed reintegrated in the production cycle. The high resistance of the patented material ttx01® allows to use the HPRC cases longer than any other case, reducing therefore the emissions of CO2 due to the production

 we case in **green.**

and distribution. The constant quest for suppliers complying with iso 14000 or emas certification and which are geographically close to our company is a contribute to reduce the environmental impact and represents a challenge in a world where firms usually aim only for low price suppliers not considering their possible higher environmental impact. Moreover HPRC adopts renewable sources plants for energy production to cover the energetic needs.

# Standard cases

HPRC cases are available with a standard setup if you don't need any special customization regarding the shell or the interior foam. Here are the 5 possible standard configurations.

\* CUBED FOAM



\* SOFT PADDED OPEN DECK + DIVIDERS



\* EMPTY



\* SECOND SKIN



\* INTERIOR BAG



\* PANEL FRAME MOUNTING SYSTEM AVAILABLE

# Oem cases

We are cases producers,  
if you do not find the right size or best liked design  
we will make a customized case for you

1. Product inquiry >>>> Mold + price offer
2. Contract signing >>>> Design drawing
3. Client confirmation >>>> Mold making
4. Sample checking >>>> Production arrangement

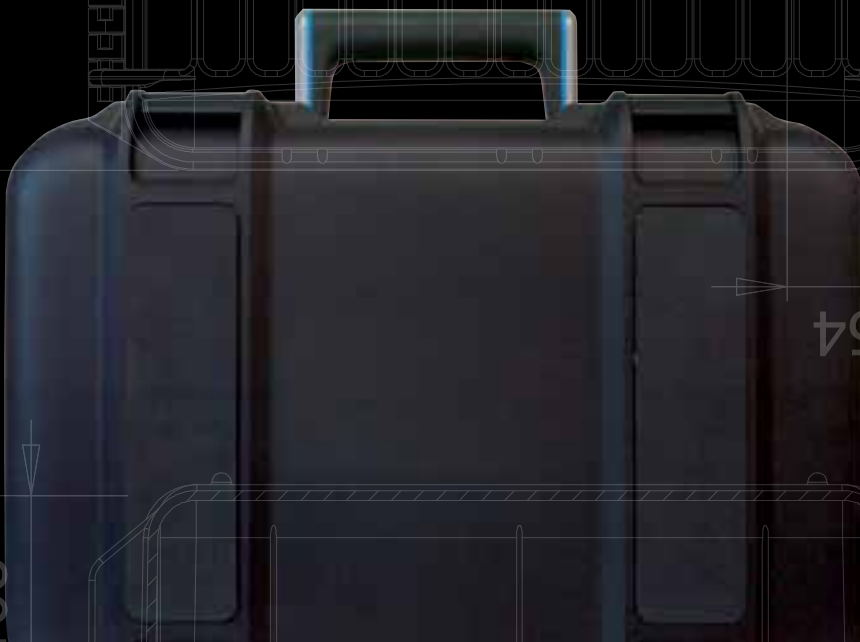

377

3400

4

103

54

105

1.5

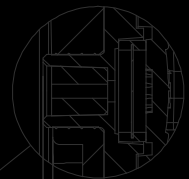

# Custom fit cases

Customization concerns: color, printing, adhesive, foam inlay (die cut, water cut, milled, moulded), thermoformed inlay, lid panels and organizer, extra working on the cases shell (holes, external applications) keeping the water tightness.



## HIGH VISIBILITY INLAYS

A special high visibility inlay can be designed in order to avoid forgetting equipment on the field after use.



## CUSTOMIZED LAYOUT

We give customers different equipment layouts options in order to optimize space and handiness.



### **CUSTOMIZED COVERS**

Customization also includes the possibility to design solutions in order to use the cover as a glove compartment. We can provide organizers, special tools addition, shell modifications and custom colors.



### **SHELL CUSTOMIZATION**

HPRC customization service also provides shell customization, including holes for external connections.

HPRC panel frame accessory (HPRCPF) allows customers to install a control panel into the case, ensuring a perfect fit.



### **INJECTION INLAYS**

The custom inlay made in expanded polypropylene of different densities guarantees a perfect protection and a professional look to the case. Our service includes the initial study of the mould and goes through the prototype phase and final production.



### **MILLED FOAMS**

The milling technology allows to get one piece inlays with many different depths.



### **WATER CUTTING TECHNOLOGY FOAMS**

Expanded polyethylene foams are available in various densities (Kg/m<sup>3</sup>), resistance to compression (kPal) and resistance to different temperatures ranges (°C). These foams, produced with water cutting technology, guarantee a good protection and allow a wide range of customizations.



### **MULTY LAYER**

A multi layer case is a handy solution, especially when equipment is made of many small and different parts that must be stored and protected into one case only.

# HPRC 1100



## TECHNICAL FEATURES

### Dimension:

internal dimension 57x58x25,5(mm) - 2.24x2.28x1.00(in)  
external dimension 69x80x32(mm) - 2.72x3.15x1.26(in)



lid: 12,8(mm) - 0.50(in) bottom: 12,7(mm) - 0.50(in)

### Weight:

empty: 0,04kg - 0.09lbs

available empty or with memory card storage

### Temperature rating:

Minimum Maximum  
-40°C -40°F +80°C +176°F

### Colors:

Black

## TECHNICAL DRAWING

## EXTERNAL DIMENSION

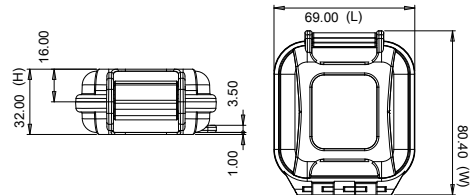

\* memory card case

\* empty case



**APPROVALS**  
ATA 300  
IP67  
STANAG 4280  
DS 81-41

**TEST**  
DROP  
IMPACT  
HANDLE  
WATERTIGHT INTEGRITY  
UV COLOR AND MATERIAL  
PROTECTION



## FEATURES

- Removable multiformat memory card holder
- Accepted card Formats:
  - max 4 of SD cards
  - 2 of XQD cards
  - 2 of CF cards
- Full/empty indicator



Both models with our trademark  
"Full - Empty" switch: just flip the arrow towards  
the desired E-F position and get straight access  
to your cards.





## TECHNICAL FEATURES

### Dimension:

internal dimension 116,1x67,6x25,6(mm) - 4.57x2.66x1(in)  
external dimension 127,5x90x32(mm) - 5.02x3.54x1.26(in)



lid: 12,8(mm) - 0.50(in) bottom: 12,7(mm) - 0.50(in)

### Weight:

empty: 0,09kg - 0.19lbs

available empty or with memory card storage

### Temperature rating:

Minimum Maximum  
-40°C -40°F +80°C +176°F

### Colors:

Black

## TECHNICAL DRAWING

## EXTERNAL DIMENSION

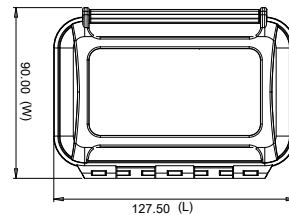
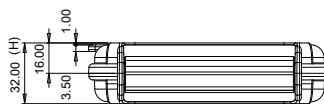

\* cubed foam



\* memory card case



**APPROVALS**  
ATA 300  
IP67  
STANAG 4280  
DS 81-41

**TEST**  
DROP  
IMPACT  
HANDLE  
WATERTIGHT INTEGRITY  
UV COLOR AND MATERIAL  
PROTECTION



## FEATURES

- Removable multiformat memory card holder
- Accepted card Formats:
  - 8 of SD cards
  - 4 of XQD cards
  - 4 of CF cards
- Full/empty indicator



# HPRC 1400



## TECHNICAL FEATURES

### Dimension:

internal dimension 180x110x40(mm) - 7.08x4.33x1.57(in)  
external dimension 200,3x142,4x48(mm) - 7.89x5.61x1.89(in)



lid: 20(mm) - 0.78(in) bottom: 20(mm) - 0.78(in)

### Weight:

empty: 0,26kg - 0,57lbs  
**available empty or with cubed foam**

### Temperature rating:

Minimum Maximum  
-40°C -40°F +80°C +176°F

### Colors:

Black

## TECHNICAL DRAWING

## EXTERNAL DIMENSION

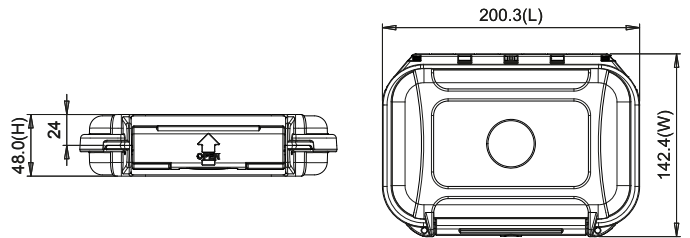

\* empty



\* cubed foam



### APPROVALS

ATA 300  
IP67  
STANAG 4280  
DS 81-41

### TEST

DROP  
IMPACT  
HANDLE  
WATERTIGHT INTEGRITY  
UV COLOR AND MATERIAL  
PROTECTION





# HPRC 2100



## TECHNICAL FEATURES

### Dimension:

internal dimension 214,5x150,5x94,4(mm) - 8.44x5.93x3.72(in)  
external dimension 235,5x201,2x110,4(mm) - 9.27x7.92x4.35(in)



lid: 18(mm) - 0.71(in) bottom: 76(mm) - 2.99(in)

### Weight:

empty: 0,74kg - 1.63lbs  
with cubed foam: 0,84kg - 1.85lbs

### Temperature rating:

Minimum Maximum  
-40°C -40°F +80°C +176°F

### Colors:

Black - Orange - Ferrari red - Electric blue

## TECHNICAL DRAWING

## EXTERNAL DIMENSION

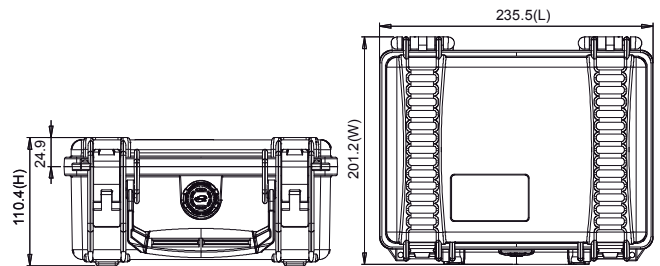

\* cubed foam



\* interior bag



**APPROVALS**  
ATA 300  
IP67  
STANAG 4280  
DS 81-41

**TEST**  
DROP  
IMPACT  
HANDLE  
WATERTIGHT INTEGRITY  
UV COLOR AND MATERIAL  
PROTECTION



## ACCESSORIES

<b>HPRCCUB2100</b> CUBED FOAM USA:HPRCFO (foam only)	<b>HPRCLO708TSA</b> PADLOCK - TSA	<b>HPRCBAG2100</b> INTERIOR BAG USA:HPRCIC (internal case)	<b>HPRCPF-001</b> PANEL FRAME (panel not included)	<b>DRYKEEPER</b> ZAC-DRYKPR



## TECHNICAL FEATURES

### Dimension:

internal dimension 236x182x108(mm) - 9.29x7.17x4.25(in)  
external dimension 258x244,3x123,3(mm) - 10.16x9.62x4.85(in)



lid: 29(mm) - 1.14(in) bottom: 79(mm) - 3.11(in)

### Weight:

empty: 0,87kg - 1.92lbs  
with cubed foam: 1,08kg - 2.38lbs

### Temperature rating:

Minimum -40°C -40°F      Maximum +80°C +176°F

### Colors:

Black

## TECHNICAL DRAWING

## EXTERNAL DIMENSION

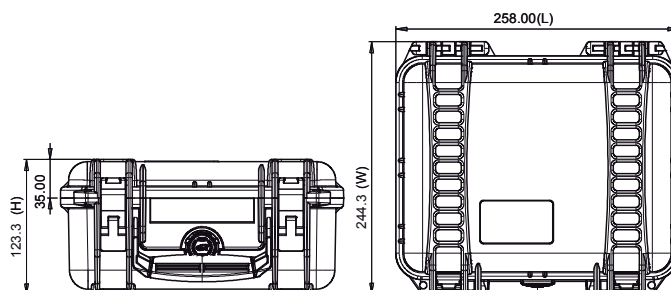

\* cubed foam



\* interior bag



**APPROVALS**  
ATA 300  
IP67  
STANAG 4280  
DS 81-41

**TEST**  
DROP  
IMPACT  
HANDLE  
WATERTIGHT INTEGRITY  
UV COLOR AND MATERIAL  
PROTECTION



## ACCESSORIES

<b>HPRCCUB2200</b> CUBED FOAM USA:HPRCFO (foam only)	<b>HPRCL0708TSA</b> PADLOCK - TSA	<b>HPRCBAG2200</b> INTERIOR BAG USA:HPRCIC (internal case)	<b>HPRCPF-002</b> PANEL FRAME (panel not included)	<b>DRYKEEPER</b> ZAC-DRYKPR

# HPRC 2250



## TECHNICAL FEATURES

### Dimension:

internal dimension 236x182x155(mm) - 9.29x7.17x6.10(in)  
external dimension 258x230x170(mm) - 10.16x9.06x6.69(in)



lid: 29(mm) - 1.14(in) bottom: 126(mm) - 4.96(in)

### Weight:

empty: 1,00kg - 2.20lbs  
with cubed foam: 1,35kg - 2.97lbs

### Temperature rating:

Minimum -40°C -40°F      Maximum +80°C +176°F

### Colors:

Black

## TECHNICAL DRAWING

## EXTERNAL DIMENSION

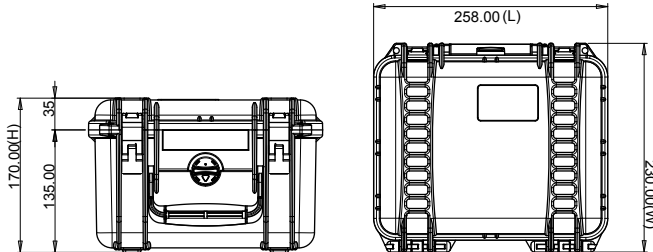

<p>* cubed foam</p>	<p>* interior bag</p>	<p><b>APPROVALS</b> ATA 300 IP67 STANAG 4280 DS 81-41</p>	<p><b>TEST</b> DROP IMPACT HANDLE WATERTIGHT INTEGRITY UV COLOR AND MATERIAL PROTECTION</p>	

## ACCESSORIES

<p><b>HPRCCUB2250</b> CUBED FOAM USA:HPRCFO (foam only)</p>	<p><b>HPRCLO708TSA</b> PADLOCK - TSA</p>	<p><b>HPRCBAG2250</b> INTERIOR BAG USA:HPRCIC (internal case)</p>	<p><b>HPRCPF-002</b> PANEL FRAME (panel not included)</p>	<p><b>DRYKEEPER</b> ZAC-DRYKPR</p>
---	--	---	---	--



## TECHNICAL FEATURES

### Dimension:

internal dimension 305,7x232,4x137,5(mm) - 12.04x9.15x5.41 (in)  
external dimension 334,6x303x155,2(mm) - 13.17x11.93x6.11(in)



lid: 31(mm) - 1.22(in) bottom: 106(mm) - 4.17(in)

### Weight:

empty: 1,75kg - 3.86lbs  
with cubed foam: 1,90kg - 4.19lbs

### Temperature rating:

Minimum Maximum  
-40°C -40°F +80°C +176°F

### Colors:

Black - Orange - Ferrari red - Electric blue

## TECHNICAL DRAWING

## EXTERNAL DIMENSION

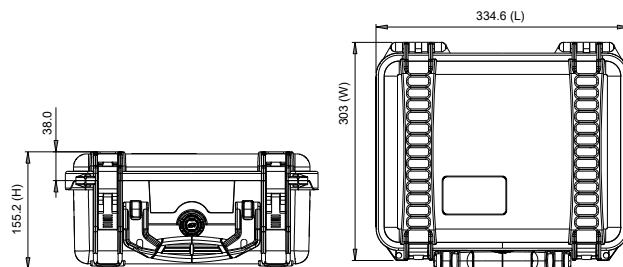

\* cubed foam



\* interior bag



**APPROVALS**  
ATA 300  
IP67  
STANAG 4280  
DS 81-41

**TEST**  
DROP  
IMPACT  
HANDLE  
WATERTIGHT INTEGRITY  
UV COLOR AND MATERIAL  
PROTECTION



## ACCESSORIES

<b>HPRCCUB2300</b> CUBED FOAM USA:HPRCFO (foam only)	<b>HPRCLO708TSA</b> PADLOCK - TSA	<b>HPRCBAG2300</b> INTERIOR BAG USA:HPRCIC (internal case)	<b>HPRCPF-003</b> PANEL FRAME (panel not included)	<b>DRYKEEPER</b> ZAC-DRYKPR

# HPRC 2350



## TECHNICAL FEATURES

### Dimension:

internal dimension 340x235x99(mm) - 13.39x9.25x3.90(in)  
external dimension 365x293x115,5(mm) - 14.37x11.54x4.55(in)



lid: 29(mm) - 1.14(in) bottom: 70(mm) - 2.75(in)



### Weight:

empty: 1.49kg - 3.29lbs  
with cubed foam: 1.66kg - 3.65lbs

### Temperature rating:

Minimum Maximum  
-40°C -40°F +80°C +176°F

### Colors:

Black

## TECHNICAL DRAWING

## EXTERNAL DIMENSION

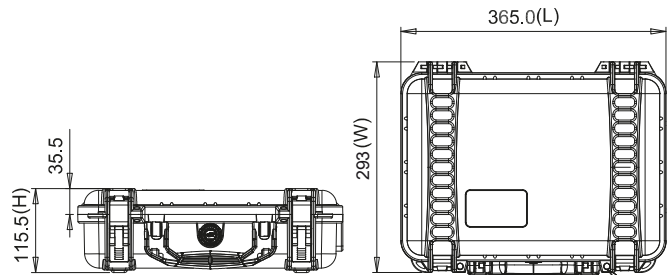

\* cubed foam



**APPROVALS**  
ATA 300  
IP67  
STANAG 4280  
DS 81-41

**TEST**  
DROP  
IMPACT  
HANDLE  
WATERTIGHT INTEGRITY  
UV COLOR AND MATERIAL  
PROTECTION



## ACCESSORIES

**HPRCCF2350**  
CUBED FOAM  
USA:HPRCFO (foam only)

**HPRCSTRAP**

**HPRCLO708TSA**  
PADLOCK - TSA

**DRYKEEPER**  
ZAC-DRYKPR

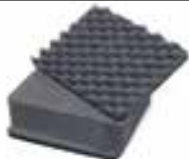





## TECHNICAL FEATURES

### Dimension:

internal dimension 377x263,9x150,8(mm) - 14.84x10.39x5.94(in)  
external dimension 402X330,5X169,2(mm) - 15.83x13.01x6.66(in)



lid: 45(mm) - 1.77(in) bottom: 107(mm) - 4.21(in)

### Weight:

empty: 2,23kg - 4.92lbs  
with cubed foam: 2,58kg - 5.69lbs



### Temperature rating:

Minimum -40°C -40°F Maximum +80°C +176°F

### Colors:

Black - Orange - Ferrari red - Electric blue

## TECHNICAL DRAWING

## EXTERNAL DIMENSION

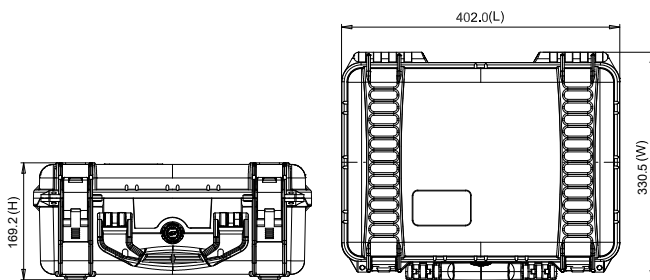

<p>* cubed foam</p>	<p>* interior bag</p>	<p><b>APPROVALS</b> ATA 300 IP67 STANAG 4280 DS 81-41</p> <p><b>TEST</b> DROP IMPACT HANDLE WATERTIGHT INTEGRITY UV COLOR AND MATERIAL PROTECTION</p>

## ACCESSORIES

<p><b>HPRCCUB2400</b> CUBED FOAM USA:HPRCFO (foam only)</p>	<p><b>HPRCLO708TSA</b> PADLOCK - TSA</p>	<p><b>HPRCBAG2400</b> INTERIOR BAG USA:HPRCIC (internal case)</p>	<p><b>HPRCORG2400</b> LID ORGANIZER</p>	<p><b>HPRCPF-004</b> PANEL FRAME (panel not included)</p>	<p><b>DRYKEEPER</b> ZAC-DRYKPR</p>
---	--	---	---	---	--

# HPRC 2460



## TECHNICAL FEATURES

**Dimension:**  
 internal dimension 409x306x175(mm) - 16.10x12.05x6.89(in)  
 external dimension 435x377,8x193(mm) - 17.13x14.87x7.60(in) **lit 21.5**

lid: 70(mm) - 2.76(in) bottom: 105(mm) - 4.14(in)

**Weight:**  
 empty: 2,55kg - 5.62lbs  
 with cubed foam: 3,14kg - 6.92lbs

**Temperature rating:**  
 Minimum -40°C -40°F Maximum +80°C +176°F

**Colors:**  
 Black

## TECHNICAL DRAWING

## EXTERNAL DIMENSION

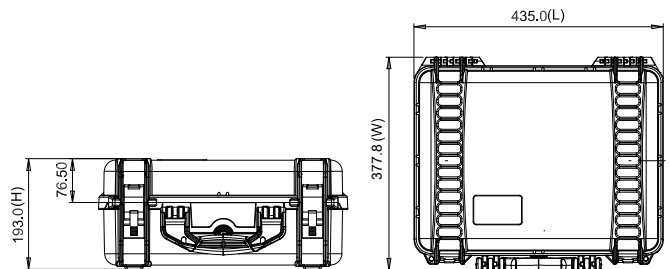

\* cubed foam

\* interior bag



**APPROVALS**  
 ATA 300  
 IP67  
 STANAG 4280  
 DS 81-41

**TEST**  
 DROP  
 IMPACT  
 HANDLE  
 WATERTIGHT INTEGRITY  
 UV COLOR AND MATERIAL  
 PROTECTION



## ACCESSORIES

<p><b>HPRCCUB2460</b>          CUBED FOAM          USA:HPRCFO (foam only)</p> 	<p><b>HPRCLO708TSA</b>          PADLOCK - TSA</p> 	<p><b>HPRCBAG2460</b>          INTERIOR BAG          USA:HPRCIC (internal case)</p> 	<p><b>HPRCORG2460</b>          LID ORGANIZER</p> 	<p><b>HPRCPF-005</b>          PANEL FRAME          (panel not included)</p> 	<p><b>DRYKEEPER</b>          ZAC-DRYKPR</p> 
--	---	---	--	--	---



## TECHNICAL FEATURES

### Dimension:

internal dimension 449,8x322,9x174,9(mm) - 17.71x12.71x6.89(in)  
external dimension 478,1x389,4x194(mm) - 18.82x15.33x7.64(in)



lid: 46(mm) - 1.81(in) bottom: 129(mm) - 5.08(in)

### Weight:

empty: 3,08kg - 6.79lbs  
with cubed foam: 3,71kg - 8.18lbs



### Temperature rating:

Minimum -40°C -40°F      Maximum +80°C +176°F

### Colors:

Black - Orange - Ferrari red - Electric blue

## TECHNICAL DRAWING

## EXTERNAL DIMENSION

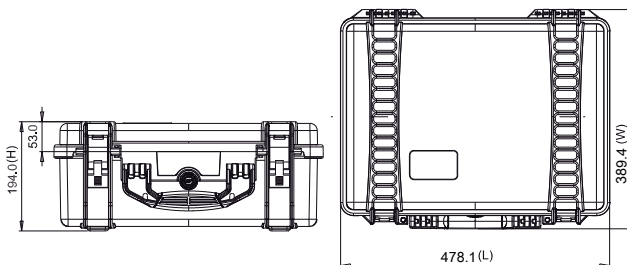

* cubed foam	* interior bag	* soft padded open deck + dividers	<b>APPROVALS</b> ATA 300 IP67 STANAG 4280 DS 81-41	<b>TEST</b> DROP IMPACT HANDLE WATERTIGHT INTEGRITY UV COLOR AND MATERIAL PROTECTION	

## ACCESSORIES

<b>HPRCCUB2500</b> CUBED FOAM USA:HPRCFO (foam only)	<b>HPRCLO708TSA</b> PADLOCK - TSA	<b>DRYKEEPER</b> ZAC-DRYKPR	<b>HPRCBAG2500</b> INTERIOR BAG USA:HPRCIC (internal case)	<b>HPRCORG2500</b> LID ORGANIZER	<b>HPRCPF-006</b> PANEL FRAME (panel not included)	<b>HPRCSFD2500</b> SOFT PADDED OPEN DECK + DIVIDERS USA: HPRCDK (divider kit)

# HPRC 2530



## TECHNICAL FEATURES

### Dimension:

internal dimension 513x288x132(mm) - 20.20x11.34x5.20(in)  
external dimension 540x350x153(mm) - 21.26x13.78x6.02(in)



lid: 46(mm) - 1.81(in) bottom: 86(mm) - 3.25(in)

### Weight:

empty: 3,20kg - 7.05lbs  
with cubed foam: 3,26kg - 7.19lbs

### Temperature rating:

Minimum -40°C -40°F Maximum +80°C +176°F

### Colors:

Black

## TECHNICAL DRAWING

## EXTERNAL DIMENSION

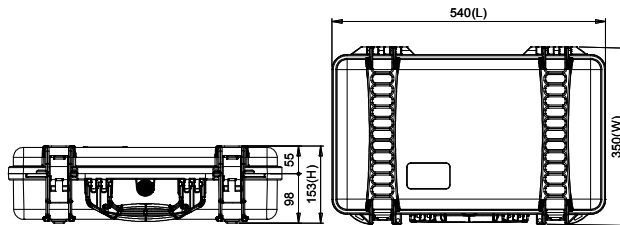

\* cubed foam

\* soft padded open deck + dividers



**APPROVALS**  
ATA 300  
IP67  
STANAG 4280  
DS 81-41

**TEST**  
DROP  
IMPACT  
HANDLE  
WATERTIGHT INTEGRITY  
UV COLOR AND MATERIAL  
PROTECTION



## ACCESSORIES

**HPRCCUB2530**  
CUBED FOAM  
USA:HPRCFO (foam only)

**HPRCLO708TSA**  
PADLOCK - TSA

**DRYKEEPER**  
ZAC-DRYKPR

**HPRCORG2530**  
LID ORGANIZER

**HPRCSFD2530** SOFT PADDED  
OPEN DECK + DIVIDERS USA:  
HPRCDK (divider kit)





PRADA

PRADA

PRADA  
Dc  
C4

PRADA  
Bc  
1

PRADA  
C6

PRADA  
Aa  
C4

PRADA  
Aa  
C4

# HPRC 2550W

WHEELED



## TECHNICAL FEATURES

### Dimension:

internal dimension 513x288x200(mm) - 20.19x11.34x7.87(in)  
external dimension 549x346x236(mm) - 21.61x13.62x9.29(in)



lid: 48(mm) - 1.88(in) bottom: 152(mm) - 5.98(in)



### Weight:

empty: 4,82kg - 10.63lbs  
with cubed foam: 5,51kg - 12.15lbs



### Temperature rating:

Minimum -40°C -40°F Maximum +80°C +176°F

### Colors:

Black - Orange - Ferrari red - Electric blue - Gravel Grey

## TECHNICAL DRAWING

## EXTERNAL DIMENSION

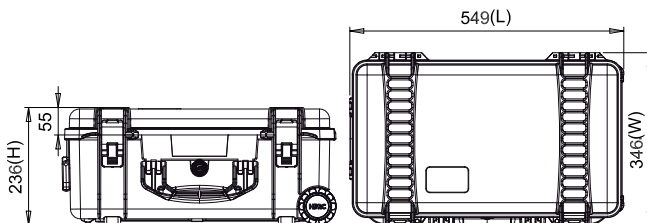

\* cubed foam



\* interior bag



\* second skin

SECOND SKIN



**APPROVALS**  
ATA 300  
IP67  
STANAG 4280  
DS 81-41

**TEST**  
DROP  
IMPACT  
HANDLE  
WATERTIGHT INTEGRITY  
UV COLOR AND MATERIAL  
PROTECTION

lt volume in litres



## ACCESSORIES

**HPRCCUB2550W**  
CUBED FOAM  
USA:HPRCFO (foam only)



**HPRCLO708TSA**  
PADLOCK - TSA



**HPRCBAG2550W**  
INTERIOR BAG  
USA:HPRCIC (internal case)



**HPRCORG-004**  
LID ORGANIZER



**HPRCSSK2550W**  
SECOND SKIN



**DRYKEEPER**  
ZAC-DRYKPR



**HPRCPF-006**  
PANEL FRAME  
(panel not included)





## TECHNICAL FEATURES

### Dimension:

internal dimension 390x310x89(mm) - 15.35x12.20x3.50(in)  
external dimension 411x364,8x110(mm) - 16.18x14.36x4.33(in)



lid: 44(mm) - 1.73(in) bottom: 45(mm) - 1.77(in)

### Weight:

empty: 2,40kg - 5.29lbs  
with cubed foam: 2,57kg - 5.67lbs



### Temperature rating:

Minimum -40°C -40°F Maximum +80°C +176°F



### Colors:

Black

## TECHNICAL DRAWING

## EXTERNAL DIMENSION

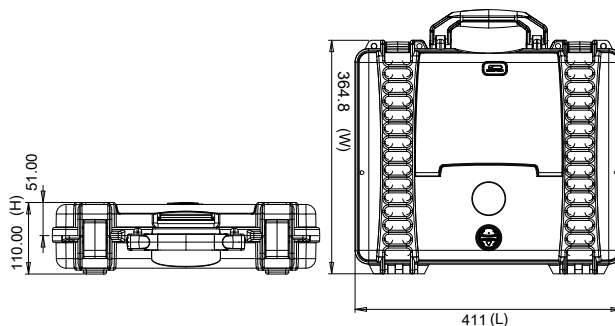

\* cubed foam

\* interior bag



**APPROVALS**  
ATA 300  
IP67  
STANAG 4280  
DS 81-41

**TEST**  
DROP  
IMPACT  
HANDLE  
WATERTIGHT INTEGRITY  
UV COLOR AND MATERIAL  
PROTECTION



## ACCESSORIES

**HPRCCUB2580**  
CUBED FOAM  
USA:HPRCFO (foam only)

**HPRCLO708TSA**  
PADLOCK - TSA

**HPRCSTRAP**

**HPRCORG2580**  
LID ORGANIZER

**DRYKEEPER**  
ZAC-DRYKPR



# HPRC 2600



## TECHNICAL FEATURES

### Dimension:

internal dimension 482,4x358,3x198,1(mm) - 18.99x14.10x7.80(in)  
external dimension 543,4x426,8x218,1(mm) - 21.39x16.8x8.59(in)



lid: 46(mm) - 1.81(in) bottom: 152(mm) - 5.98(in)

### Weight:

empty: 4,25kg - 9.37lbs  
with cubed foam: 5,05kg - 11.13lbs

### Temperature rating:

Minimum Maximum  
-40°C -40°F +80°C +176°F

### Colors:

Black - Orange - Ferrari red - Electric blue

## TECHNICAL DRAWING

## EXTERNAL DIMENSION

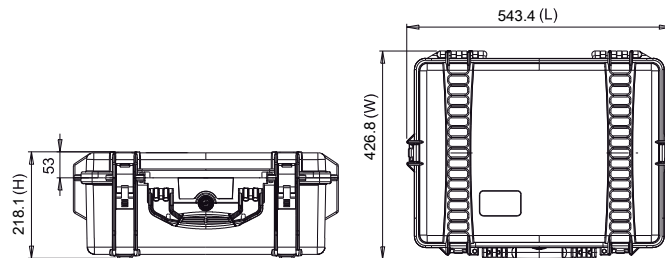

\* cubed foam



\* interior bag



\* second skin



**APPROVALS**  
ATA 300  
IP67  
STANAG 4280  
DS 81-41

**TEST**  
DROP  
IMPACT  
HANDLE  
WATERTIGHT INTEGRITY  
UV COLOR AND MATERIAL  
PROTECTION



## ACCESSORIES

**HPRCCUB2600**  
CUBED FOAM  
USA:HPRCFO (foam only)



**HPRCLO708TSA**  
PADLOCK - TSA



**DRYKEEPER**  
ZAC-DRYKPR



**HPRCBAG2600**  
INTERIOR BAG  
USA:HPRCIC (internal case)



**HPRCORG2600**  
LID ORGANIZER



**HPRPCF-007**  
PANEL FRAME  
(panel not included)



**HPRCSSK2600**  
SECOND SKIN





# HPRC 2600W

WHEELED



## TECHNICAL FEATURES

**Dimension:**  
 internal dimension 482,4x358,3x217,6(mm) - 18.99x14.1x8.57(in)  
 external dimension 546,9x426,8x250,7(mm) - 21.53x16.8x9.87(in)

**lt38**

**W**

lid: 46(mm) - 1.81(in) bottom: 172(mm) - 6.77(in)

**Weight:**  
 empty: 6,05kg - 13.34lbs  
 with cubed foam: 6,97kg - 15.37lbs

**Temperature rating:**  
 Minimum -40°C -40°F  
 Maximum +80°C +176°F

**Colors:**  
 Black - Orange - Electric blue - Gravel Grey

## TECHNICAL DRAWING

## EXTERNAL DIMENSION

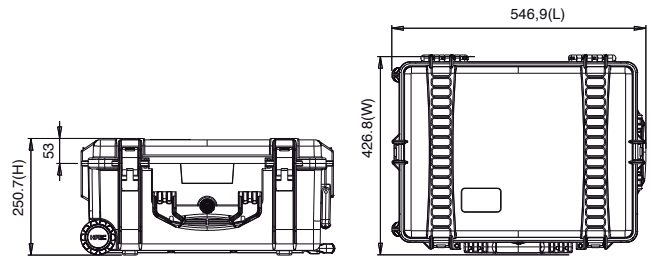

* cubed foam	* interior bag	second skin	<b>APPROVALS</b> ATA 300 IP67 STANAG 4280 DS 81-41	<b>TEST</b> DROP IMPACT HANDLE WATERTIGHT INTEGRITY UV COLOR AND MATERIAL PROTECTION	lt volume in litres wheeled <b>W</b>

## ACCESSORIES

<b>HPRCCUB2600W</b> CUBED FOAM USA:HPRCFO (foam only)	<b>HPRCLO708TSA</b> PADLOCK - TSA	<b>DRYKEEPER</b> ZAC-DRYKPR	<b>HPRCBAG600W</b> INTERIOR BAG USA:HPRCIC (internal case)	<b>HPRCORG2600W</b> LID ORGANIZER	<b>HPRCPF-007</b> PANEL FRAME (panel not included)	<b>HPRCSSK2600W</b> SECOND SKIN

# HPRC 2700



## TECHNICAL FEATURES

### Dimension:

internal dimension 555x459x205(mm) - 21.85x18.07x8.07(in)  
external dimension 617x525x227(mm) - 24.29x20.67x8.94(in)



lid: 45(mm) - 1.77(in) bottom: 160(mm) - 6.29(in)

### Weight:

empty: 5,55kg - 12.24lbs  
with cubed foam: 6,71kg - 14.79lbs

### Temperature rating:

Minimum Maximum  
-40°C -40°F +80°C +176°F

### Colors:

Black - Orange - Ferrari red

## TECHNICAL DRAWING

## EXTERNAL DIMENSION

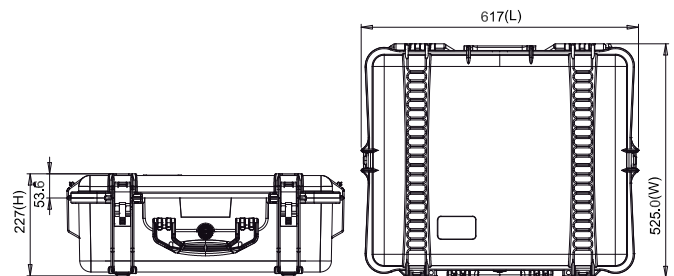

\* cubed foam



\* interior bag



**APPROVALS**  
ATA 300  
IP67  
STANAG 4280  
DS 81-41

**TEST**  
DROP  
IMPACT  
HANDLE  
WATERTIGHT INTEGRITY  
UV COLOR AND MATERIAL  
PROTECTION



## ACCESSORIES

**HPRCCUB2700**  
CUBED FOAM  
USA:HPRCFO (foam only)



**HPRCLO708TSA**  
PADLOCK - TSA



**HPRCBAG2700**  
INTERIOR BAG  
USA:HPRCIC (internal case)



**HPRCORG2700**  
LID ORGANIZER



**HPRCPF-008**  
PANEL FRAME  
(panel not included)



**DRYKEEPER**  
ZAC-DRYKPR



# HPRC 2700W

WHEELED



## TECHNICAL FEATURES

**Dimension:**  
 internal dimension 554,7x458,7x246(mm) - 21.84x18.06x9.69(in)  
 external dimension 617,5x527,3x279,6(mm) - 24.31x20.76x11.0(in)

lt65

lid: 45(mm) - 1.77(in) bottom: 201(mm) - 7.91(in)

W

**Weight:**  
 empty: 7,75kg - 17.09lbs  
 with cubed foam: 9,07kg - 19.99lbs

**Temperature rating:**  
 Minimum -40°C -40°F Maximum +80°C +176°F

**Colors:**  
 Black - Orange - Ferrari red - Gravel Grey

## TECHNICAL DRAWING

## EXTERNAL DIMENSION

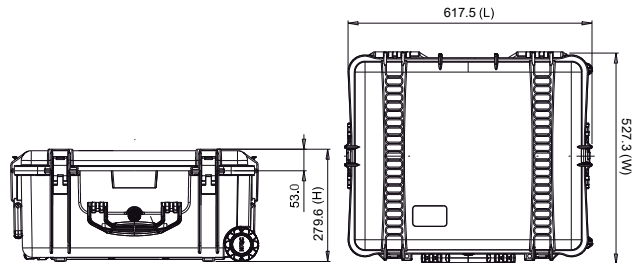

\* cubed foam



\* interior bag



\* second skin



**APPROVALS**  
 ATA 300  
 IP67  
 STANAG 4280  
 DS 81-41

**TEST**  
 DROP  
 IMPACT  
 HANDLE  
 WATERTIGHT INTEGRITY  
 UV COLOR AND MATERIAL  
 PROTECTION

lt volume in litres  
 W wheeled

## ACCESSORIES

**HPRCCUB2700W**  
 CUBED FOAM  
 USA:HPRCFO (foam only)



**HPRCLO708TSA**  
 PADLOCK - TSA



**DRYKEEPER**  
 ZAC-DRYKFR



**HPRCBAG2700W**  
 INTERIOR BAG  
 USA:HPRCIC (internal case)



**HPRCORG2700W**  
 LID ORGANIZER



**HPRCSSK2700W**  
 SECOND SKIN



**HPRCPF-008**  
 PANEL FRAME  
 (panel not included)



# HPRC 2710



## TECHNICAL FEATURES

### Dimension:

internal dimension 555x459x256(mm) - 21.85x18.07x10.08(in)  
external dimension 617x525x280(mm) - 24.29x20.67x11.02(in)



lid: 45(mm) - 1.77(in) bottom: 211(mm) - 8.30(in)

### Weight:

empty: 6.56kg - 14.46lbs  
with cubed foam: 7,96kg - 17.55

### Temperature rating:

Minimum Maximum  
-40°C -40°F +80°C +176°F

### Colors:

Black

## TECHNICAL DRAWING

## EXTERNAL DIMENSION

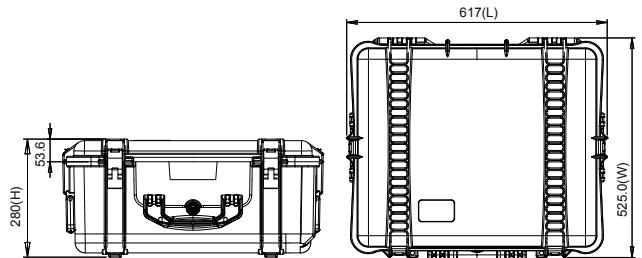

\* cubed foam



**APPROVALS**  
ATA 300  
IP67  
STANAG 4280  
DS 81-41

**TEST**  
DROP  
IMPACT  
HANDLE  
WATERTIGHT INTEGRITY  
UV COLOR AND MATERIAL  
PROTECTION



## ACCESSORIES

HPRCCUB2710 CUBED FOAM USA:HPRCFO (foam only)	HPRCLO708TSA PADLOCK - TSA	HPRCPF-008 PANEL FRAME (panel not included)	HPRCORG2710 LID ORGANIZER	DRYKEEPER ZAC-DRYKPR

# HPRC 2730W

WHEELED



## TECHNICAL FEATURES

**Dimension:**  
 internal dimension 503x459x316(mm) - 19.80x18.07x12.44(in)  
 external dimension 616,9x531x349,6(mm) - 24.29x20.91x13.76(in)



lid: 45(mm) - 1.77(in) bottom: 269(mm) - 10.59(in)

**Weight:**  
 empty: 8,41kg - 18.54lbs  
 with cubed foam: 10,43kg - 22.99lbs

**Temperature rating:**  
 Minimum -40°C -40°F      Maximum +80°C +176°F

**Colors:**  
 Black

## TECHNICAL DRAWING

## EXTERNAL DIMENSION

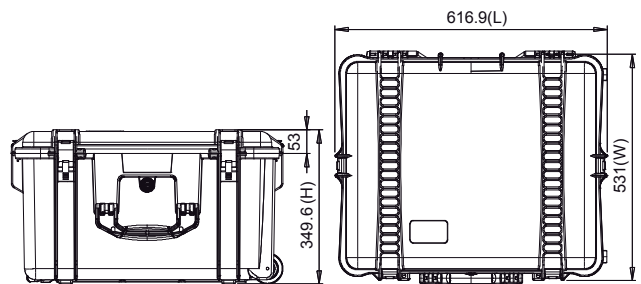

* cubed foam	* interior bag	* soft padded open deck + dividers	<b>APPROVALS</b> ATA 300 IP67 STANAG 4280 DS 81-41	<b>TEST</b> DROP IMPACT HANDLE WATERTIGHT INTEGRITY UV COLOR AND MATERIAL PROTECTION	lt volume in litres wheeled

## ACCESSORIES

<b>HPRCCUB2730W</b> CUBED FOAM USA:HPRCFO (foam only)	<b>HPRCLO708TSA</b> PADLOCK - TSA	<b>HPRCBAG2730W</b> INTERIOR BAG USA:HPRCIC (internal case)	<b>HPRCORG2730W</b> LID ORGANIZER	<b>HPRCSFD2730W</b> SOFT PADDED OPEN DECK + DIVIDERS USA: HPRCDK (divider kit)	<b>DRYKEEPER</b> ZAC-DRYKPR

# HPRC 2745W

WHEELED



## TECHNICAL FEATURES

### Dimension:

internal dimension 771x401x247(mm) - 30.35x15.78x9.72 (in)  
external dimension 822x452x294(mm) - 32.36x17.79x11.57 (in)



lid: 46(mm) - 1.81(in) bottom: 201 (mm) - 7.91(in)

### Weight:

empty: 7,38kg - 16.27lbs  
with cubed foam: 9,10kg - 20.06

### Temperature rating:

Minimum -40°C -40°F      Maximum +80°C +176°F

### Colors:

Black, Gravel Grey

## TECHNICAL DRAWING

## EXTERNAL DIMENSION

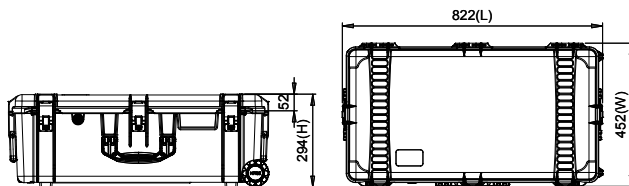

\* empty



\* cubed foam



\* second skin



**APPROVALS**  
ATA 300  
IP67  
STANAG 4280  
DS 81-41

**TEST**  
DROP  
IMPACT  
HANDLE  
WATERTIGHT INTEGRITY  
UV COLOR AND MATERIAL  
PROTECTION



## ACCESSORIES

**HPRCCUB2745W**  
CUBED FOAM  
USA:HPRCFO (foam only)



**HPRCL0708TSA**  
PADLOCK - TSA



**HPRCSSK2745W**  
SECOND SKIN



**DRYKEEPER**  
ZAC-DRYKPR





# HPRC 2760W



## When innovation becomes a case

Main features:

- 4 built in wheels: roll the case along by simply pushing it while it's on the ground
- two side handles: push or pull the case as a trolley
- stackable exterior lid design: use the case as a cart by stacking more cases on top of each other
- two lateral handles: when you need to hold the case from both sides
- comfortable soft-grip handle
- braked wheels to prevent unexpected movement





# HPRC 2760W

WHEELED



## TECHNICAL FEATURES

**Dimension:**  
 internal dimension 690x450x301(mm) - 27.16x17.72x11.85(in)  
 external dimension 750x511x329(mm) - 29.53x20.12x12.95(in)



lid: 50(mm) - 1.97(in) bottom: 250(mm) - 9.84(in)



**Weight:**  
 empty: 8,93kg - 19.69lbs  
 with cubed foam: 10,72kg - 23.63lbs

**Temperature rating:**  
 Minimum -40°C -40°F  
 Maximum +80°C +176°F

**Colors:**  
 Black

## TECHNICAL DRAWING

## EXTERNAL DIMENSION

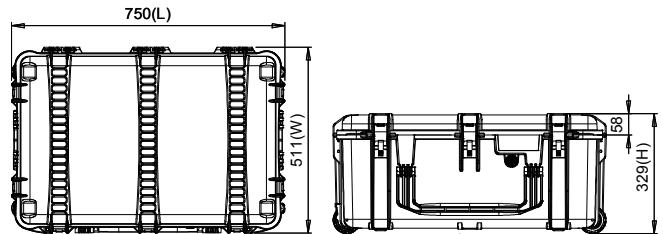

\* cubed foam



\* interior bag



\* soft padded open deck + dividers



**APPROVALS**  
 ATA 300  
 IP67  
 STANAG 4280  
 DS 81-41

**TEST**  
 DROP  
 IMPACT  
 HANDLE  
 WATERTIGHT INTEGRITY  
 UV COLOR AND MATERIAL  
 PROTECTION



## ACCESSORIES

<b>HPRCUB2760W</b> CUBED FOAM USA:HPRCFO (foam only)	<b>HPRCLO708TSA</b> PADLOCK - TSA	<b>HPRCBAG2760W</b> Interior bag USA:HPRCIC (internal case)	<b>HPRCsFD2760W</b> SOFT PADDED OPEN DECK + DIVIDERS USA: HPRCDK (divider kit)	<b>DRYKEEPER</b> ZAC-DRYKPR

# HPRC 2780W

WHEELED



## TECHNICAL FEATURES

### Dimension:

internal dimension 748,6x524,6x363,3(mm) - 29.47x20.65x14.3(in)  
external dimension 814x586,5x387,7(mm) - 32.05x23.09x15.27(in)

It 142

W

lid: 73(mm) - 2.87(in) bottom: 290 (mm) - 11.42 (in)

### Weight:

empty: 12,0kg - 26.46lbs  
with cubed foam: 16,18kg - 35.67lbs

### Temperature rating:

Minimum Maximum  
-40°C -40°F +80°C +176°F

### Colors:

Black

## TECHNICAL DRAWING

## EXTERNAL DIMENSION

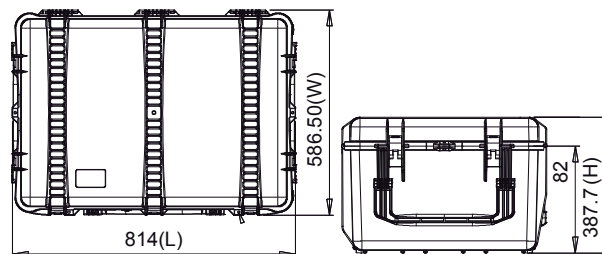

* cubed foam	* interior bag	* soft padded open deck + dividers	<b>APPROVALS</b> ATA 300 IP67 STANAG 4280 DS 81-41	<b>TEST</b> DROP IMPACT HANDLE WATERTIGHT INTEGRITY UV COLOR AND MATERIAL PROTECTION	It volume in litres W wheeled

## ACCESSORIES

<b>HPRCCUB2780W</b> CUBED FOAM USA:HPRCFO (foam only)	<b>HPRCLO708TSA</b> PADLOCK - TSA	<b>HPRCBAG2780W</b> INTERIOR BAG USA:HPRCIC (internal case)	<b>HPRCORG2780W</b> LID ORGANIZER	<b>HPRCSFD2780W</b> SOFT PADDED OPEN DECK + DIVIDERS USA: HPRCDK (divider kit)	<b>DRYKEEPER</b> ZAC-DRYKPR

# HPRC 2800W

WHEELED



## TECHNICAL FEATURES

**Dimension:**  
 internal dimension 748,6x524,6x454,6(mm) - 29.47x20.65x17.9(in)  
 external dimension 813,3x586,5x480,5(mm) - 32.02x23.09x18.92(in)

**It 179**

lid: 73(mm) - 2.87(in) bottom: 382(mm) - 15.03(in)

**W**

**Weight:**  
 empty: 13,25kg - 29,22lbs  
 with cubed foam: 17,43kg - 38,43lbs

**Temperature rating:**  
 Minimum -40°C -40°F  
 Maximum +80°C +176°F

**Colors:**  
 Black

## TECHNICAL DRAWING

## EXTERNAL DIMENSION

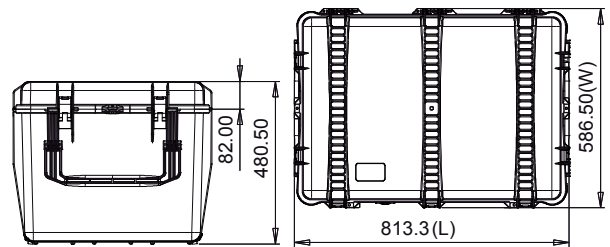

\* cubed foam



\* interior bag



**APPROVALS**  
 ATA 300  
 IP67  
 STANAG 4280  
 DS 81-41

**TEST**  
 DROP  
 IMPACT  
 HANDLE  
 WATERTIGHT INTEGRITY  
 UV COLOR AND MATERIAL  
 PROTECTION

**It** volume in litres  
**W** wheeled

## ACCESSORIES

**HPRCCUB2800W**  
 CUBED FOAM  
 USA:HPRCFO (foam only)



**HPRCLO708TSA**  
 PADLOCK - TSA



**HPRCBAG2800W**  
 INTERIOR BAG  
 USA:HPRCIC (internal case)



**HPRCORG2800W**  
 LID ORGANIZER



**DRYKEEPER**  
 ZAC-DRYKPR



# HPRC 3500



## TECHNICAL FEATURES

### Dimension:

internal dimension 433,5x319,3x168,8(mm) - 17.07x12.57x6.65(in)  
external dimension 497,9x370,3x184,9(mm) - 19.6x14.58x7.28(in)



lid: 72(mm) - 2.83(in) bottom: 97(mm) - 3.81(in)

### Weight:

empty: 3,00kg - 6.61lbs  
with cubed foam: 3,55kg - 7.82lbs



### Temperature rating:

Minimum Maximum  
-40°C -40°F +80°C +176°F

### Colors:

Black

## TECHNICAL DRAWING

## EXTERNAL DIMENSION

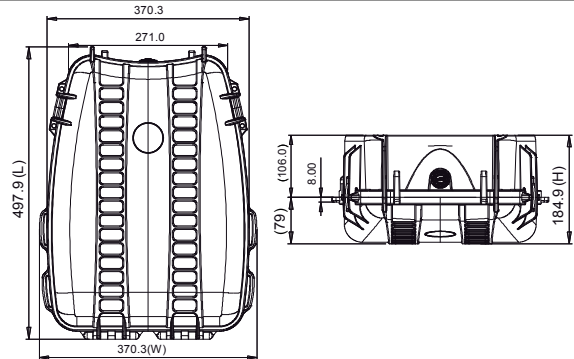

\* cubed foam



\* interior bag



**APPROVALS**  
ATA 300  
IP67  
STANAG 4280  
DS 81-41

**TEST**  
DROP  
IMPACT  
HANDLE  
WATERTIGHT INTEGRITY  
UV COLOR AND MATERIAL  
PROTECTION



## ACCESSORIES

**HPRCCUB3500**  
CUBED FOAM  
USA:HPRCFO (foam only)



**HPRCBAG3500**  
INTERIOR BAG  
USA:HPRCIC (internal case)



**HPRCORG3500**  
LID ORGANIZER



**DRYKEEPER**  
ZAC-DRYKPR





## TECHNICAL FEATURES

### Dimension:

internal dimension 479x354x194(mm) - 18.86x13.94x7.64(in)  
external dimension 542x402x220(mm) - 21.34x15.83x8.66(in)



lid: 80(mm) - 3.15(in) bottom: 114(mm) - 4.48(in)

### Weight:

empty: 3,22kg - 7.10lbs  
with cubed foam: 3,85kg - 8.49lbs

### Temperature rating:

Minimum Maximum  
-40°C -40°F +80°C +176°F

### Colors:

Black

## TECHNICAL DRAWING

## EXTERNAL DIMENSION

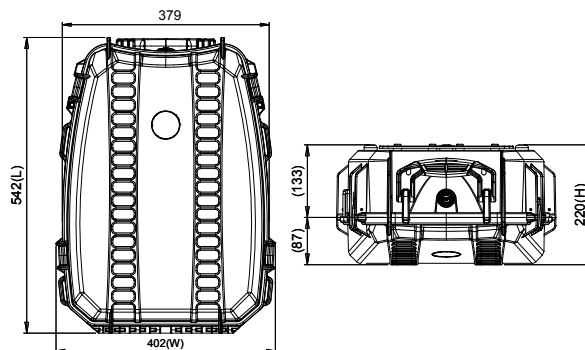

empty	cubed foam	second skin	<b>APPROVALS</b> ATA 300 IP67 STANAG 4280 DS 81-41	<b>TEST</b> DROP IMPACT HANDLE WATERTIGHT INTEGRITY UV COLOR AND MATERIAL PROTECTION	

## ACCESSORIES

<b>HPRCCUB3600</b> CUBED FOAM USA:HPRCFO (foam only)	<b>HPRCLO708TSA</b> PADLOCK - TSA	<b>HPRCSSK3600</b> SECOND SKIN	<b>DRYKEEPER</b> ZAC-DRYKPR

# HPRC 4050

SHOULDER  
CASE



## TECHNICAL FEATURES

### Dimension:

internal dimension 261x171x220(mm) - 10.28x6.73x8.66(in)  
external dimension 284x223x260(mm) - 11.18x8.78x10.24(in)

### Internal dimension:

Lid: 46(mm) - 1.81(in) - under handle: 24(mm) - 0.94(in)  
Bottom: 196(mm) - 7.71(in)

### Weight:

empty: 1,82kg - 4.01lbs  
with cubed foam: 1,85kg - 4.07lbs

### Temperature rating:

Minimum Maximum  
-40°C -40°F +80°C +176°F

### Colors:

Black



## TECHNICAL DRAWING

## EXTERNAL DIMENSION

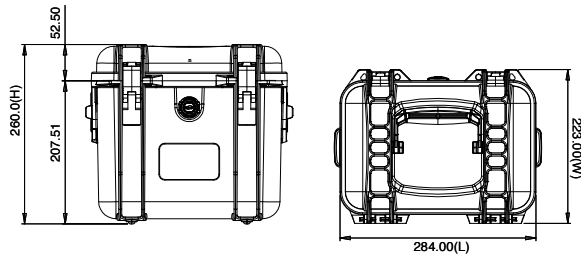

* cubed foam	* soft padded open deck + dividers	<b>APPROVALS</b> ATA 300 IP67 STANAG 4280 DS 81-41	<b>TEST</b> DROP IMPACT HANDLE WATERTIGHT INTEGRITY UV COLOR AND MATERIAL PROTECTION	

## ACCESSORIES

<b>HPRCCUB4050</b> CUBED FOAM USA:HPRCFO (foam only)	<b>HPRCLO708TSA</b> PADLOCK - TSA	<b>HPRCPADDEDSTRAP</b>	<b>HPRCSFD4050</b> SOFT PADDED OPEN DECK + DIVIDERS USA: HPRCDK (divider kit)	<b>HPRCPANELFRAME</b> SUPPORT KIT	<b>DRYKEEPER</b> ZAC-DRYKPR

**SHOULDER  
CASE**



## TECHNICAL FEATURES

### Dimension:

internal dimension 401x231x231(mm) - 15.79x9.09x9.09(in)  
external dimension 426.3x284x276,5(mm) - 16.78x11.18x10.89(in)



### Internal dimension:

Lid: 46(mm) - 1.81(in) - under handle: 18.5 (mm) - 0.73(in)  
Bottom: 212,50(mm) - 8.37(in)



### Weight:

empty: 2,64kg - 5.82lbs  
with cubed foam: 3,27kg - 7.20lbs

### Temperature rating:

Minimum Maximum  
-40°C -40°F +80°C +176°F

### Colors:

Black

## TECHNICAL DRAWING

## EXTERNAL DIMENSION

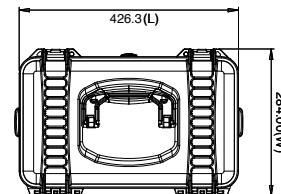
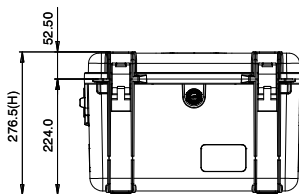

<p>* cubed foam      * soft padded open deck + dividers</p>		<p><b>APPROVALS</b> ATA 300 IP67 STANAG 4280 DS 81-41</p>	<p><b>TEST</b> DROP IMPACT HANDLE WATERTIGHT INTEGRITY UV COLOR AND MATERIAL PROTECTION</p>	

## ACCESSORIES

<p><b>HPRCUB4100</b> CUBED FOAM USA:HPRCFO (foam only)</p>	<p><b>HPRCLO708TSA</b> PADLOCK - TSA</p>	<p><b>HPRCPADDEDSTRAP</b></p>	<p><b>HPRCSFD4100</b> SOFT PADDED OPEN DECK + DIVIDERS USA: HPRCDK (divider kit)</p>	<p><b>HPRCPANELFRAME</b> SUPPORT KIT</p>	<p><b>DRYKEEPER</b> ZAC-DRYKPR</p>
--	--	-------------------------------	--	--	--

# HPRC 4200

SHOULDER  
CASE



## TECHNICAL FEATURES

**Dimension:**  
internal dimension 460x240x400(mm) - 18.11x9.45x15.75(in)  
external dimension 500,4x293x443,5(mm) - 19.7x11.54x17.46(in)

**lit44**

Internal dimension:  
Lid: 66(mm) - 2.60(in) - under handle: 38.5 (mm) - 1.52(in)  
Bottom: 361,50(mm) - 14.23(in)

**Weight:**  
empty: 3,91kg - 8.62lbs  
with cubed foam: 5,10kg - 11.24lbs

**Temperature rating:**  
Minimum Maximum  
-40°C -40°F +80°C +176°F

**Colors:**  
Black

## TECHNICAL DRAWING

## EXTERNAL DIMENSION

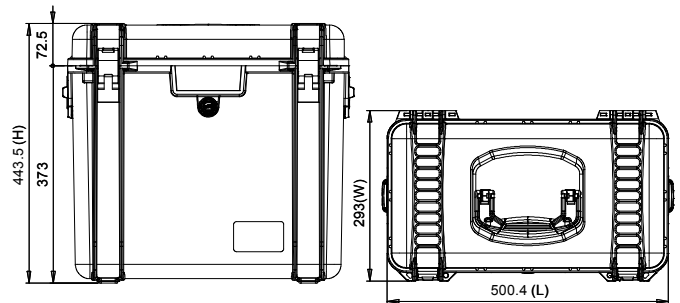

\* cubed foam



**APPROVALS**  
ATA 300  
IP67  
STANAG 4280  
DS 81-41

**TEST**  
DROP  
IMPACT  
HANDLE  
WATERTIGHT INTEGRITY  
UV COLOR AND MATERIAL  
PROTECTION



## ACCESSORIES

HPRCCUB4200 CUBED FOAM USA:HPRCFO (foam only)	HPRCLO708TSA PADLOCK - TSA	HPRCPADDEDSTRAP	HPRCPANELFRAME SUPPORT KIT	DRYKEEPER ZAC-DRYKPR





## TECHNICAL FEATURES

### Dimension:

internal dimension 580x320x309(mm) - 22.83x12.60x12.16(in)  
external dimension 690x380x355,40(mm) - 27.16x14.96x13.99(in)

### Internal dimension:

Lid: 80(mm) - 3.15(in) - under handle: 54(mm) - 2.13(in)  
Bottom: 255(mm) - 10.04(in)

### Weight:

empty: 6,50kg - 14.33lbs  
with cubed foam: 7,96kg - 17.54lbs

### Temperature rating:

Minimum Maximum  
-40°C -40°F +80°C +176°F

### Colors:

Black



## TECHNICAL DRAWING

## EXTERNAL DIMENSION

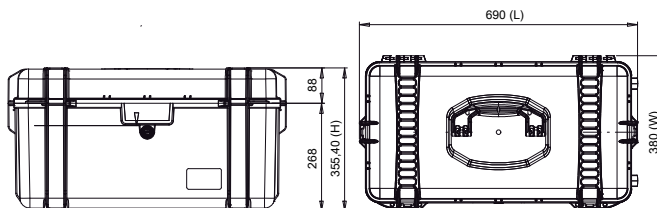

			<p><b>APPROVALS</b> ATA 300 IP67 STANAG 4280 DS 81-41</p>	<p><b>TEST</b> DROP IMPACT HANDLE WATERTIGHT INTEGRITY UV COLOR AND MATERIAL PROTECTION</p>	<p>volume in litres wheeled</p>
* cubed foam	* interior bag	* soft padded open deck + dividers			

## ACCESSORIES

<p><b>HPRCCUB4300</b> CUBED FOAM USA:HPRCFO (foam only)</p>	<p><b>HPRCLO708TSA</b> PADLOCK - TSA</p>	<p><b>HPRCBAG4300</b> INTERIOR BAG USA:HPRCIC (internal case)</p>	<p><b>HPRCSFD4300</b> SOFT PADDED OPEN DECK + DIVIDERS USA: HPRCDK (divider kit)</p>	<p><b>DRYKEEPER</b> ZAC-DRYKPR</p>
---	--	---	--	--

# HPRC 4300W

WHEELED



## TECHNICAL FEATURES

### Dimension:

internal dimension 580x320x299(mm) - 22.83x12.60x11.77(in)  
external dimension 690x380x358,20(mm) - 27.16x14.96x14.10(in)



### Internal dimension:

Lid: 80(mm) - 3.15(in) - under handle: 54(mm) - 2.13(in)  
Bottom: 245(mm) - 9.65(in)

### Weight:

empty: 7.30kg - 16.09lbs  
with cubed foam: 8,76kg - 19.31lbs

### Temperature rating:

Minimum Maximum  
-40°C -40°F +80°C +176°F

### Colors:

Black

## TECHNICAL DRAWING

## EXTERNAL DIMENSION

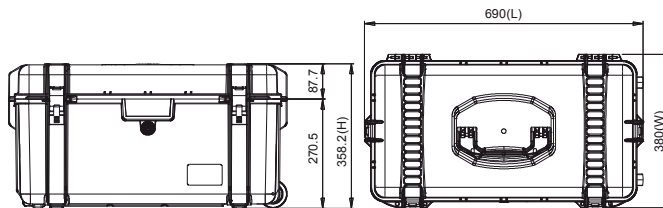

**APPROVALS**  
ATA 300  
IP67  
STANAG 4280  
DS 81-41

**TEST**  
DROP  
IMPACT  
HANDLE  
WATERTIGHT INTEGRITY  
UV COLOR AND MATERIAL  
PROTECTION



\* cubed foam

\* interior bag

\* soft padded open deck + dividers

## ACCESSORIES

**HPRCCUB4300W**  
CUBED FOAM  
USA:HPRCFO (foam only)

**HPRCLO708TSA**  
PADLOCK - TSA

**HPRCBAG4300W**  
INTERIOR BAG  
USA:HPRCIC (internal case)

**HPRCSFD4300W** SOFT PADDED  
OPEN DECK + DIVIDERS USA:  
HPRCDK (divider kit)

**DRYKEEPER**  
ZAC-DRYKPR





## TECHNICAL FEATURES

### Dimension:

internal dimension 420x420x389(mm) - 16.54x16.54x15.31(in)  
external dimension 482x481x437(mm) - 18.98x18.94x17.20(in)

**lit 74**

### Internal dimension:

Lid: 65(mm) - 2.56(in) - under handle: 33(mm) - 1.30(in)  
Bottom: 356(mm) - 14(in)

### Weight:

empty: 6,70kg - 14.77lbs  
with cubed foam: 8,90kg - 19.62lbs

### Temperature rating:

Minimum Maximum  
-40°C -40°F +80°C +176°F

### Colors:

Black

## TECHNICAL DRAWING

## EXTERNAL DIMENSION

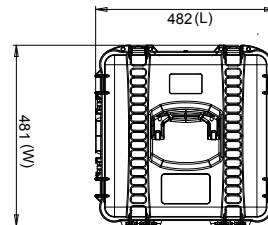
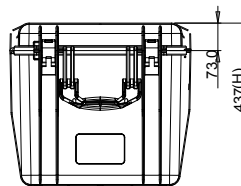

\* cubed foam



**APPROVALS**  
ATA 300  
IP67  
STANAG 4280  
DS 81-41

**TEST**  
DROP  
IMPACT  
HANDLE  
WATERTIGHT INTEGRITY  
UV COLOR AND MATERIAL  
PROTECTION



## ACCESSORIES

**HPRCUB4400**  
CUBED FOAM  
USA:HPRCFO (foam only)



**HPRCLO708TSA**  
PADLOCK - TSA



**HPRCKITW4400**  
wheel kit for 4400



**DRYKEEPER**  
ZAC-DRYKPR



# HPRC 4600W

WHEELED



## TECHNICAL FEATURES

### Dimension:

internal dimension 611x611x375(mm) - 24.05x24.05x14.76(in)  
external dimension 670x677x418,5(mm) - 26.38x26.65x16.4(in)



lid: 85.5(mm) - 3.36(in) bottom: 289(mm) - 11.37(in)



### Weight:

empty: 10,28kg - 22.66lbs  
with cubed foam: 13,14kg - 28.97lbs

### Temperature rating:

Minimum -40°C -40°F Maximum +80°C +176°F

### Colors:

Black

## TECHNICAL DRAWING

## EXTERNAL DIMENSION

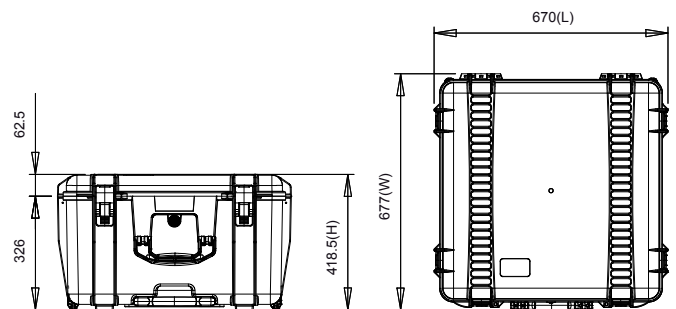

\* cubed foam



**APPROVALS**  
ATA 300  
IP67  
STANAG 4280  
DS 81-41

**TEST**  
DROP  
IMPACT  
HANDLE  
WATERTIGHT INTEGRITY  
UV COLOR AND MATERIAL  
PROTECTION



## ACCESSORIES

**HPRCCUB4600W**  
CUBED FOAM  
USA:HPRCF0 (foam only)



**HPRCLO708TSA**  
PADLOCK - TSA



**DRYKEEPER**  
ZAC-DRYKPR





# HPRC 4700W

WHEELED



## TECHNICAL FEATURES

### Dimension:

internal dimension 508x301,4x497(mm) - 20.00x11.87x19.57(in)  
external dimension 572x429x563,5(mm) - 22.52x16.89x22.19(in)

### Internal dimension:

Lid: 49(mm) - 1.92(in) - under handle: 23(mm) - 0.91(in)  
Bottom: 474(mm) - 18.66(in)

### Weight:

empty: 11,73kg - 25.86lbs  
with cubed foam: 14,84kg - 32.71lbs

### Temperature rating:

Minimum Maximum  
-40°C -40°F +80°C +176°F

### Colors:

Black



## TECHNICAL DRAWING

## EXTERNAL DIMENSION

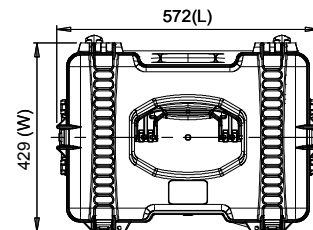
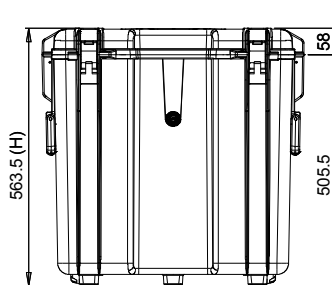

\* cubed foam



\* interior bag



**APPROVALS**  
ATA 300  
IP67  
STANAG 4280  
DS 81-41

**TEST**  
DROP  
IMPACT  
HANDLE  
WATERTIGHT INTEGRITY  
UV COLOR AND MATERIAL  
PROTECTION



## ACCESSORIES

**HPRCCUB4700W**  
CUBED FOAM  
USA:HPRCFO (foam only)



**HPRCLO708TSA**  
PADLOCK - TSA



**HPRCBAG4700W**  
Interior bag  
USA:HPRCIC (internal case)



**DRYKEEPER**  
ZAC-DRYKPR



# HPRC 4800W

WHEELED



## TECHNICAL FEATURES

### Dimension:

internal dimension 720x320x600(mm) - 28.34x12.60x23.62(in)  
external dimension 776x380x649(mm) - 30.55x14.96x25.55(in)



### Internal dimension:

Lid: 85(mm) - 3.35(in) - under handle: 59(mm) - 2.32(in)  
Bottom: 540(mm) - 21.25(in)



### Weight:

empty: 10,00kg - 22.21lbs  
with cubed foam: 14,10kg - 31.08lbs

### Temperature rating:

Minimum Maximum  
-40°C -40°F +80°C +176°F

### Colors:

Black

## TECHNICAL DRAWING

## EXTERNAL DIMENSION

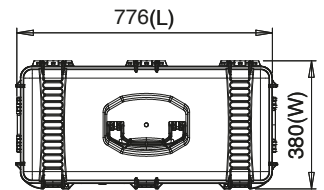
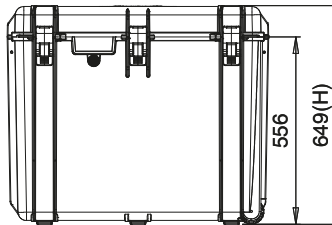

\* cubed foam



**APPROVALS**  
ATA 300  
IP67  
STANAG 4280  
DS 81-41

**TEST**  
DROP  
IMPACT  
HANDLE  
WATERTIGHT INTEGRITY  
UV COLOR AND MATERIAL  
PROTECTION



## ACCESSORIES

**HPRCCUB4800W**  
CUBED FOAM  
USA:HPRCF0 (foam only)



**HPRCLO708TSA**  
PADLOCK - TSA



**DRYKEEPER**  
ZAC-DRYKPR







**HPRC5200R.  
THE ONLY PROTECTIVE CASE  
THAT BECOMES BACKPACK IN SECONDS**

# HPRC 5200

NEW



## TECHNICAL FEATURES

### Dimension:

internal dimension 772x302x210(mm) - 30.39x11.89x8.26 (in)  
external dimension 802x355x246.7(mm) - 31.57x13.97x9.71 (in)  
lid 62(mm) - 2.44(in) bottom: 164(mm) - 6.45(in)

### Weight:

empty: 5.05kg - 11.1lbs

### Temperature rating:

Minimum -40°C -40°F Maximum +80°C +176°F

### Colors:

Black

## EXTERNAL DIMENSION



## TECHNICAL DRAWINGS

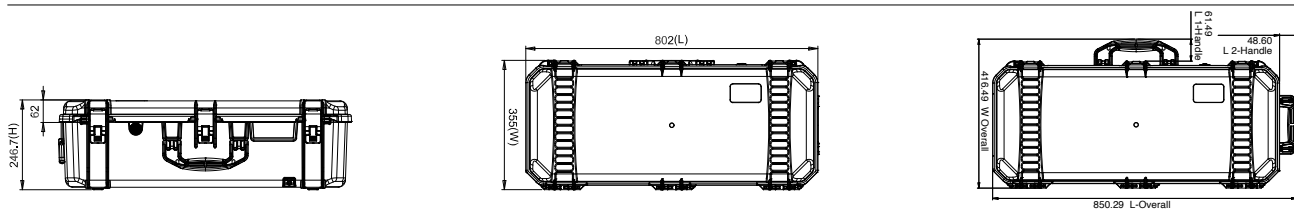

## INTERNAL LAYOUTS



## ACCESSORIES

### HPRCCUB5200

CUBED FOAM  
USA:HPRCF0 (foam only)

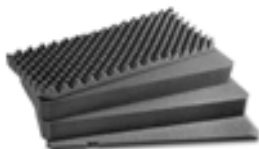

### HPRCLO708TSA

PADLOCK - TSA



### HPRCSSK5200

SECOND SKIN



### DRYKEEPER

ZAC-DRYKPR



## APPROVALS AND TESTS



ATA 300  
IP67  
STANAG 4280  
DS 81-41

DROP  
IMPACT  
HANDLE  
WATERTIGHT INTEGRITY  
UV COLOR AND MATERIAL  
PROTECTION

# HPRC 5200R NEW



## TECHNICAL FEATURES

**Dimension:**  
 internal dimension 772x302x210(mm) - 30.39x11.89x8.26 (in)  
 external dimension 802x355x246.7(mm) - 31.57x13.97x9.71 (in)  
 lid 62(mm) - 2.44(in) bottom: 164(mm) - 6.45(in)

**Weight:**  
 empty: 5.05kg – 11.1lbs

**Temperature rating:**  
 Minimum -40°C -40°F      Maximum +80°C +176°F

**Colors:**  
 Black

## EXTERNAL DIMENSION



## TECHNICAL DRAWINGS

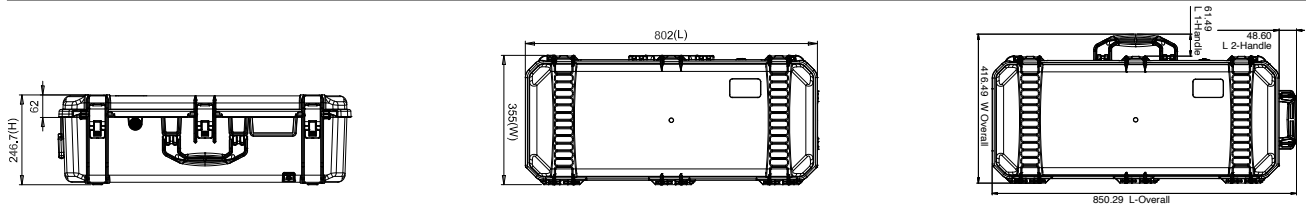



## INTERNAL LAYOUTS



## ACCESSORIES

<b>HPRCCUB5200</b> CUBED FOAM USA:HPRCF0 (foam only)	<b>HPRCLO708TSA</b> PADLOCK - TSA	<b>HPRCSSK5200</b> SECOND SKIN	<b>DRYKEEPER</b> ZAC-DRYKPR

## APPROVALS AND TESTS

ATA 300  
 IP67  
 STANAG 4280  
 DS 81-41

DROP  
 IMPACT  
 HANDLE  
 WATERTIGHT INTEGRITY  
 UV COLOR AND MATERIAL  
 PROTECTION

Photo by Phil Arntz



# HPRC 5400W

WHEELED



## TECHNICAL FEATURES

**Dimension:**  
 internal dimension 1140x350x160(mm) - 44.88x13.78x6.30(in)  
 external dimension 1203,7x418x181(mm) - 47.39x16.46x7.13(in)

**lit64**

lid: 45(mm) - 1.77(in) bottom: 115(mm) - 4.52(in)

**W**

**Weight:**  
 empty: 8,0kg - 17.64lbs  
 with cubed foam: 8,80kg - 19.40lbs

**Temperature rating:**  
 Minimum -40°C -40°F  
 Maximum +80°C +176°F

**Colors:**  
 Black

## TECHNICAL DRAWING

## EXTERNAL DIMENSION

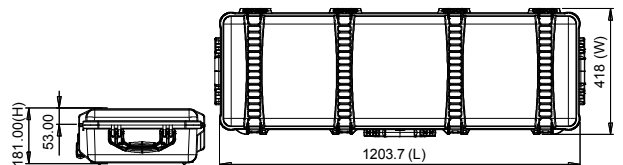

\* cubed foam



\* interior bag



**APPROVALS**  
 ATA 300  
 IP67  
 STANAG 4280  
 DS 81-41

**TEST**  
 DROP  
 IMPACT  
 HANDLE  
 WATERTIGHT INTEGRITY  
 UV COLOR AND MATERIAL  
 PROTECTION

**lit64**  
 volume in litres  
**W**  
 wheeled

## ACCESSORIES

<p><b>HPRCCUB5400W</b>                  CUBED FOAM                  USA:HPRCFO (foam only)</p>	<p><b>HPRCLO708TSA</b>                  PADLOCK - TSA</p>	<p><b>HPRCBAG5400W</b>                  INTERIOR BAG                  USA:HPRCIC (internal case)</p>	<p><b>DRYKEEPER</b>                  ZAC-DRYKPR</p>
			

# HPRC 6200



## TECHNICAL FEATURES

### Dimension:

internal dimension 651x279x242,8(mm) - 25.63x10.98x9.56(in)  
external dimension 711x335x301,3(mm) - 28x13.19x11.86(in)



lid: 112(mm) - 4.41(in) bottom: 131(mm) - 5.15(in)

### Weight:

empty: 3,96kg - 8.73lbs  
with cubed foam: 5,80kg - 12.78lbs

### Temperature rating:

Minimum -40°C -40°F      Maximum +80°C +176°F

### Colors:

Black

## TECHNICAL DRAWING

## EXTERNAL DIMENSION

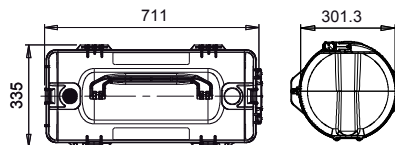

\* cubed foam



\* tri version



**APPROVALS**  
ATA 300  
IP67  
STANAG 4280  
DS 81-41

**TEST**  
DROP  
IMPACT  
HANDLE  
WATERTIGHT INTEGRITY  
UV COLOR AND MATERIAL  
PROTECTION



## ACCESSORIES

**HPRCUB6200**  
CUBED FOAM  
USA:HPRCFO (foam only)



**HPRCTRI6200**  
for tripods



**HPRCSTRAP**



**HPRCLO708TSA**  
PADLOCK - TSA



**DRYKEEPER**  
ZAC-DRYKPR



# HPRC 6300W

WHEELED



## TECHNICAL FEATURES

### Dimension:

internal dimension 920,8x279x242,8(mm) - 36.25x10.98x9.56(in)  
external dimension 968x335x299,8(mm) - 38.11x13.19x11.8(in)



lid: 112(mm) - 4.41(in) bottom: 131(mm) - 5.15(in)

### Weight:

empty: 6,14kg - 13.54lbs  
with cubed foam: 6,95kg - 15.32lbs

### Temperature rating:

Minimum Maximum  
-40°C -40°F +80°C +176°F

### Colors:

Black

## TECHNICAL DRAWING

## EXTERNAL DIMENSION

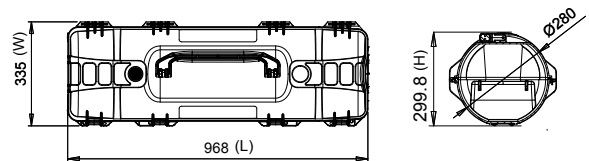

\* cubed foam



\* tri version



**APPROVALS**  
ATA 300  
IP67  
STANAG 4280  
DS 81-41

**TEST**  
DROP  
IMPACT  
HANDLE  
WATERTIGHT INTEGRITY  
UV COLOR AND MATERIAL  
PROTECTION

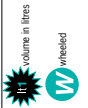

## ACCESSORIES

**HPRCUB6300W**  
CUBED FOAM  
USA:HPRCFO (foam only)



**HPRCTRIPKIT**  
for tripods



**HPRCSTRAP**



**HPRCLO708TSA**  
PADLOCK - TSA



**DRYKEEPER**  
ZAC-DRYKPR



# HPRC 6400W

WHEELED



## TECHNICAL FEATURES

### Dimension:

internal dimension 1081x279x242,8(mm) - 42.56x10.98x9.56(in)  
external dimension 1128x335x299,8(mm) - 44.41x13.19x11.8(in)

lid: 112(mm) - 4.41(in) bottom: 131(mm) - 5.15(in)

### Weight:

empty: 6,44kg - 14.2lbs  
with cubed foam: 7,84kg - 17.28lbs

### Temperature rating:

Minimum Maximum  
-40°C -40°F +80°C +176°F

### Colors:

Black



## TECHNICAL DRAWING

## EXTERNAL DIMENSION

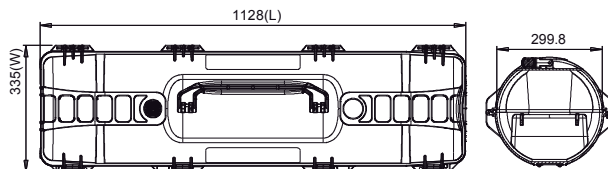

\* cubed foam

\* tri version



**APPROVALS**  
ATA 300  
IP67  
STANAG 4280  
DS 81-41

**TEST**  
DROP  
IMPACT  
HANDLE  
WATERTIGHT INTEGRITY  
UV COLOR AND MATERIAL  
PROTECTION



## ACCESSORIES

**HPRCCUB6400W**  
CUBED FOAM  
USA:HPRCFO (foam only)

**HPRCTRIKIT**  
for tripods

**HPRCSTRAP**

**HPRCLO708TSA**  
PADLOCK - TSA

**DRYKEEPER**  
ZAC-DRYKPR





# HPRC 6500W

WHEELED



## TECHNICAL FEATURES

**Dimension:**  
 internal dimension 1280,7x279x242,8(mm) - 50.42x10.98x9.56(in)  
 external dimension 1328x335x299,8(mm) - 52.28x13.19x11.8(in)

**lt76**

lid: 112(mm) - 4.41(in) bottom: 131(mm) - 5.15(in)

**W**

**Weight:**  
 empty: 7,2kg - 15.88lbs  
 with cubed foam: 9,03kg - 19.90lbs

**Temperature rating:**  
 Minimum -40°C -40°F      Maximum +80°C +176°F

**Colors:**  
 Black

## TECHNICAL DRAWING

## EXTERNAL DIMENSION

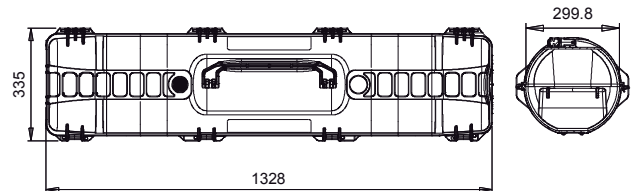

\* cubed foam

\* tri version



**APPROVALS**  
 ATA 300  
 IP67  
 STANAG 4280  
 DS 81-41

**TEST**  
 DROP  
 IMPACT  
 HANDLE  
 WATERTIGHT INTEGRITY  
 UV COLOR AND MATERIAL  
 PROTECTION

**lt76**  
 volume in litres  
 wheeled  
**W**

## ACCESSORIES

HPRCCUB6500W CUBED FOAM USA:HPRCFO (foam only)	HPRCTRIKIT for tripods	HPRCSTRAP	HPRCLO708TSA PADLOCK - TSA	DRYKEEPER ZAC-DRYKPR

# HPRC 0500



## TECHNICAL FEATURES

### Dimension:

closed 394x280x27,5(mm) - 15.51x11.02x1.08(in)  
open 464x350x27,5(mm) - 18.26x13.77x1.08(in)

### Weight:

empty: 0,95kg - 2.09lbs

### Temperature rating:

Minimum -40°C -40°F      Maximum +80°C +176°F

### Colors:

Black

## TECHNICAL DRAWING

## EXTERNAL DIMENSION

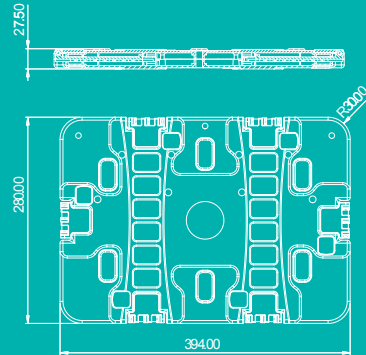

\* tripod, laptop and scheller not included



### APPROVALS

ATA 300  
IP67  
STANAG 4280  
DS 81-41

### TEST

DROP  
IMPACT  
HANDLE  
WATERTIGHT INTEGRITY  
UV COLOR AND MATERIAL  
PROTECTION





**READY TO USE**

**EXHAUSTED**  
(TO BE REGENERATED)

## PROTECT YOUR GEAR

Dry Keeper is a special container designed to protect your items from mildew, deterioration and damages caused by high humidity. The orange spherical Silica Gel is composed of a naturally occurring mineral silicon dioxide that is purified and processed into a beaded form. Silica Gel has a high absorption capacity and will remove moisture at temperatures as high as 150° F (65°C). Fits all cases.



## HOW TO USE

When the beads are dry, they appear orange in color, when saturated with moisture to about 15-20% by weight, the beads will change to a light blue color. Silica Gel's life is variable and it depends on the amount of moisture absorption (generally 2-4 months). To verify if it's still working, check the color: the orange Silica Gel turns to blue to indicate its complete exhaustion. Silica Gel can be regenerated by heating in the oven for 1-2 hours at 100°C (212°F). Do not leave outside, directly exposed to the sun, in an open environment.



## TECHNICAL INFORMATION

<b>Dessicant Material:</b>	Disidry's Orange Indicating Silica Gel
<b>Packaging Material:</b>	Aluminium (Container) / Paper / Stickers
<b>Aluminium Foil Thickness:</b>	0,5 mm
<b>External Diameter:</b>	81 mm
<b>Dry Keeper Thickness:</b>	17 mm
<b>Total Net Weight:</b>	30 g
<b>Internal Container Capacity:</b>	50 gr (Silica Gel)
<b>Holes:</b>	196 (98 on each side)
<b>Life:</b>	Depending on use. Generally 2-4 months (once stickers removed).
<b>Storage:</b>	Do not leave outside, directly exposed to the sun, in open environment.

# HOW DO YOU LIKE GREY?



## HPRC GRAVEL GREY

NOW AVAILABLE IN FOUR DIFFERENT SIZES.

HPRC2550W | HPRC2600W | HPRC2700W | HPRC2745W



# technical chart

## HPRC1100



**internal dimension**  
57x58x25,5(mm)  
2.24x2.28x1.00(in)



**external dimension**  
69x80x32(mm)  
2.72x3.15x1.26(in)

**weight empty**  
empty: 0,04kg - 0.09lbs

**Colors**  
Black

## HPRC1300



**internal dimension**  
116,1x67,60x25,6(mm)  
4.57x2.66x1.00(in)



**external dimension**  
127,50x90x32(mm)  
5.02x3.54x1.26(in)

**weight empty**  
empty: 0,09kg - 0.19lbs

**Colors**  
Black

## HPRC1400



**internal dimension**  
180x110x40(mm)  
7.08x4.33x1.57(in)



**external dimension**  
200,30x142,40x48(mm)  
7.89x5.61x1.89(in)

**weight empty**  
empty: 0.26kg - 0,57lbs

**Colors**  
Black

## HPRC2100



**internal dimension**  
214,5x150,5x94,4(mm)  
8.44x5.93x3.72(in)



**external dimension**  
235,50x201,20x110,40(mm)  
9.27x7.92x4.35(in)

**weight empty**  
empty: 0,74kg - 1.63lbs

**Colors**  
Black - Orange - Ferrari red -  
Electric blue

## HPRC2200



**internal dimension**  
236x182x108(mm)  
9.29x7.17x4.25(in)



**external dimension**  
258x244,3x123,3(mm)  
10.16x9.62x4.85(in)

**weight empty**  
empty: 0,87kg - 1.92lbs

**Colors**  
Black

## HPRC2250



**internal dimension**  
236x182x155(mm)  
9.29x7.17x6.10(in)



**external dimension**  
258x230x170(mm)  
10.16x9.06x6.69(in)

**weight empty**  
1,00kg - 2.20lbs

**Colors**  
Black

## HPRC2300



**internal dimension**  
305,7x232,4x137,5(mm)  
12.04x9.15x5.41(in)



**external dimension**  
334,6x303x155,2(mm)  
13.17x11.93x6.11(in)

**weight empty**  
1,75kg - 3.86lbs

**Colors**  
Black - Orange - Ferrari red -  
Electric blue

## HPRC2350



**internal dimension**  
340x235x99(mm)  
13.39x9.25x3.90(in)



**external dimension**  
365x293x115,50(mm)  
14.37x11.54x4.55(in)

**weight empty**  
1.49kg - 3.29lbs

**Colors**  
Black



## HPRC2400



**internal dimension**  
377x263,9x150,8(mm)  
14.84x10.39x5.94(in)



**external dimension**  
402x330,5x169,2(mm)  
15.83x13.01x6.66(in)

**weight empty**  
2,23kg - 4.92lbs

**Colors**  
Black - Orange - Ferrari red -  
Electric blue



## HPRC2460



**internal dimension**  
409x306x175(mm)  
16.10x12.05x6.89(in)



**external dimension**  
435x377,8x193(mm)  
17.13x14.87x7.60(in)

**weight empty**  
2,55kg - 5.62lbs

**Colors**  
Black

## HPRC2500



**internal dimension**  
449,8x322,9x174,9(mm)  
17.71x12.71x6.89(in)



**external dimension**  
478,1x389,4x194(mm)  
18.82x15.33x7.64(in)

**weight empty**  
3,08kg - 6.79lbs

**Colors**  
Black - Orange - Ferrari red -  
Electric blue



## HPRC2530



**internal dimension**  
513x288x132(mm)  
20.20x11.34x5.20(in)



**external dimension**  
540x350x153(mm)  
21.26x13.78x6.02(in)

**weight empty**  
3,20kg - 7.05lbs

**Colors**  
Black



## HPRC2550W

	<b>internal dimension</b> 513x288x200(mm) 20.19x11.34x7.87(in)
 <b>lt29</b>	<b>external dimension</b> 549x346x236(mm) 21.61x13.62x9.29(in)
 <b>W</b>	<b>weight empty</b> 4,82kg - 10.63lbs
	<b>Colors</b> Black - Orange - Ferrari red - Electric blue Gravel Grey

## HPRC2580

	<b>internal dimension</b> 390x310x89(mm) 15.35x12.20x3.50(in)
 <b>lt11</b>	<b>external dimension</b> 411x364,8x110(mm) 16.18x14.36x4.33(in)
	<b>weight empty</b> 2,40kg - 5.29lbs
	<b>Colors</b> Black

## HPRC2600

	<b>internal dimension</b> 482,4x358,3x198,1(mm) 18.99x14.1x7.8(in)
 <b>lt34</b>	<b>external dimension</b> 543,4x426,8x218,1(mm) 21.39x16.8x8.59(in)
	<b>weight empty</b> 4,25kg - 9.37lbs
	<b>Colors</b> Black - Orange - Ferrari red - Electric blue

## HPRC2600W

	<b>internal dimension</b> 482,4x358,3x217,6(mm) 18.99x14.10x8.57(in)
 <b>lt38</b>	<b>external dimension</b> 546,9x426,8x250,7(mm) 21.53x16.8x9.87(in)
 <b>W</b>	<b>weight empty</b> 6,05kg - 13.34lbs
	<b>Colors</b> Black - Orange - Electric blue Gravel Grey



## HPRC2700

	<b>internal dimension</b> 555x459x205(mm) 21.85x18.07x8.07(in)
 <b>lt52</b>	<b>external dimension</b> 617x525x227(mm) 24.29x20.67x8.94(in)
	<b>weight empty</b> 5,55kg - 12.24lbs
	<b>Colors</b> Black - Orange - Ferrari red

## HPRC2700W

	<b>internal dimension</b> 554,7x458,7x246(mm) 21.84x18.06x9.69(in)
 <b>lt65</b>	<b>external dimension</b> 617,5x527,3x279,6(mm) 24.31x20.76x11.0(in)
 <b>W</b>	<b>weight empty</b> 7,75kg - 17.09lbs
	<b>Colors</b> Black - Orange - Ferrari red - Gravel Grey

## HPRC2710

	<b>internal dimension</b> 555x459x256(mm) 21.85x18.07x10.08(in)
 <b>lt64</b>	<b>external dimension</b> 617x525x280(mm) 24.29x20.67x11.02(in)
	<b>weight empty</b> 6,56kg - 14.46lbs
	<b>Colors</b> Black



## HPRC2730W

	<b>internal dimension</b> 503x459x316(mm) 19.80x18.07x12.44(in)
 <b>lt72</b>	<b>external dimension</b> 616,9x531x349,6(mm) 24.29x20.91x13.76(in)
 <b>W</b>	<b>weight empty</b> 8,41kg - 18.54lbs
	<b>Colors</b> Black

## HPRC2745W

	<b>internal dimension</b> 771x401x247(mm) 30.35x15.78x9.72 (in)
 <b>lt77</b>	<b>external dimension</b> 822x452x294(mm) 32.36x17.79x11.57 (in)
	<b>weight empty</b> 7.38kg - 16.27lbs
	<b>Colors</b> Black, Gravel Grey



## HPRC2760W

	<b>internal dimension</b> 690x450x301(mm) 27.16x17.72x11.85(in)
 <b>lt91</b>	<b>external dimension</b> 750x511x329(mm) 29.53x20.12x12.95(in)
 <b>W</b>	<b>weight empty</b> 8,93kg - 19.69lbs
	<b>Colors</b> Black

## HPRC2780W

	<b>internal dimension</b> 748,6x524,6x363,3(mm) 29.47x20.65x14.3(in)
 <b>lt142</b>	<b>external dimension</b> 814x586,5x387,7(mm) 32.05x23.09x15.27(in)
 <b>W</b>	<b>weight empty</b> 12,0kg - 26.46lbs
	<b>Colors</b> Black

## HPRC2800W

	<b>internal dimension</b> 748,6x524,6x454,6(mm) 29.47x20.65x17.90(in)
 <b>lt179</b>	<b>external dimension</b> 813,3x586,5x480,5(mm) 32.02x23.9x18.92(in)
 <b>W</b>	<b>weight empty</b> 13,25kg - 29.22lbs
	<b>Colors</b> Black

# technical chart

## HPRC3500



**internal dimension**  
433,5x319,3x168,8(mm)  
17.07x12.57x6.65(in)



**external dimension**  
497,9x370,3x184,9(mm)  
19.60x14.58x7.28(in)

**weight empty**  
3,00kg - 6.61lbs

**Colors**  
Black

## HPRC3600



**internal dimension**  
479x354x194(mm)  
18.86x13.94x7.64(in)



**external dimension**  
542x402x220(mm )  
21.34x15.83x8.66(in)

**weight empty**  
3,22kg - 7.10lbs

**Colors**  
Black

## HPRC4050



**internal dimension**  
261x171x220(mm)  
10.28x6.73x8.66(in)



**external dimension**  
284x223x260(mm)  
11.18x8.78x10.24(in)

**weight empty**  
1,82kg - 4.01lbs



**Colors**  
Black

## HPRC4100



**internal dimension**  
401x231x231(mm)  
15.79x9.09x9.09(in)



**external dimension**  
426,3x284x276,5(mm)  
16.78x11.18x10.89(in)

**weight empty**  
2,64kg - 5.82lbs



**Colors**  
Black

## HPRC4200



**internal dimension**  
460x240x400(mm)  
18.11x9.45x15.75(in)



**external dimension**  
500,4x293x443,5(mm)  
19.7x11.54x17.46(in)

**weight empty**  
3,91kg - 8.62lbs

**Colors**  
Black

## HPRC4300



**internal dimension**  
580x320x309(mm)  
22.83x12.60x12.16(in)



**external dimension**  
690x380x355,4(mm)  
27.16x14.96x13.99(in)

**weight empty**  
6,50kg - 14.33lbs

**Colors**  
Black

## HPRC4300W



**internal dimension**  
580x320x299(mm)  
22.83x12.60x11.77(in)



**external dimension**  
690x380x358,2(mm)  
27.16x14.96x14.1(in)

**weight empty**  
7,30kg - 16.09lbs



**Colors**  
Black

## HPRC4400



**internal dimension**  
420x420x389(mm)  
16.54x16.54x15.31(in)



**external dimension**  
482x481x437(mm)  
18.98x18.94x17.2(in)

**weight empty**  
6,70kg - 14.77lbs

**Colors**  
Black

## HPRC4600W



**internal dimension**  
611x611x375(mm)  
24.05x24.05x14.76(in)



**external dimension**  
670x677x418.5(mm)  
26.38x26.65x16.4(in)

**weight empty**  
10,28kg - 22.66lbs

**Colors**  
Black

## HPRC4700W



**internal dimension**  
508x301,4x497(mm)  
20.00x11.87x19.57(in)



**external dimension**  
572x429x563,5(mm)  
22.52x16.89x22.19(in)

**weight empty**  
11,73kg - 25.86lbs



**Colors**  
Black

## HPRC4800W



**internal dimension**  
720x320x600(mm)  
28.34x12.60x23.62(in)



**external dimension**  
776x380x649(mm)  
30.55x14.96x25.55(in)

**weight empty**  
10,00kg - 22.21lbs



**Colors**  
Black

## HPRC5200



**internal dimension**  
772x302x210(mm)  
30.39x11.89x8.26 (in)



**external dimension**  
802x355x246.7(mm)  
31.57x13.97x9,71 (in)

**weight empty**  
5.05kg - 11.1lbs

**Colors**  
Black

NEW



### HPRC5200R



**internal dimension**  
772x302x210(mm)  
30.39x11.89x8.26 (in)



**external dimension**  
802x355x246.7(mm)  
31.57x13.97x9.71 (in)

**weight empty**  
5.05kg - 11.1lbs

**Colors**  
Black

**NEW**

### HPRC5400W



**internal dimension**  
1140x350x160(mm)  
44.88x13.78x6.30(in)



**external dimension**  
1203,7x418x181(mm)  
47.39x16.46x7.13(in)

**weight empty**  
8kg - 17.64lbs

**Colors**  
Black

### HPRC6200



**internal dimension**  
651x279x242,80(mm)  
25.63x10.98x9.56(in)



**external dimension**  
711x335x301,3(mm)  
28x13.19x11.86(in)

**weight empty**  
3,96kg - 8.73lbs

**Colors**  
Black

### HPRC6300W



**internal dimension**  
920,8x279x242,8(mm)  
36.25x10.98x9.56(in)



**external dimension**  
968x335x299,8(mm)  
38.11x13.19x11.8(in)

**weight empty**  
6,14kg - 13.54lbs

**Colors**  
Black

### HPRC6400W



**internal dimension**  
1081x279x242,8(mm)  
42.56x10.98x9.56(in)



**external dimension**  
1128x335x299,8(mm)  
44.41x13.19x11.8(in)

**weight empty**  
6,44kg - 14.2lbs

**Colors**  
Black

### HPRC6500W



**internal dimension**  
1280,7x279x242,8(mm)  
50.42x10.98x9.56(in)



**external dimension**  
1328x335x299,8(mm)  
52.28x13.19x11.8(in)

**weight empty**  
7,2kg - 15.88lbs

**Colors**  
Black

### HPRC0500



**dimension closed**  
394x280x27,5(mm)  
15.51x11.02x1.08(in)

**dimension open**  
464x350x27,5(mm)  
18.26x13.77x1.08(in)

**weight empty**  
empty: 0,95kg - 2.09lbs

**Colors**  
Black



Discover all our products  
at: [www.hprc.it](http://www.hprc.it)

Plaber S.r.l reserves the right to modify its products at any time and without notice, in order to improve their quality and functionality. Therefore, all the information given in this datasheet is to be considered indicative and subject to possible modifications.

# Special soft cases

---

---



**HPRC** also produces different lines of soft cases and backpacks specifically designed to carry and protect the most popular drones of the market.



MADE IN ITALY

Find us on:



YouTube PlaberItalia  
Channel



plaber®

**Plaber s.r.l.**  
Via Div Tridentina, 10  
I-36061 Bassano del Grappa  
Vicenza - Italy

Tel +39 0424 809 150

USA office and warehouse:

**Plaber America Inc**  
110 Chestnut Ridge Rd. #314  
Montvale, NJ 07645

Phone +1(201) 989-3353

[www.hprc.it](http://www.hprc.it) | [www.hprcusa.com](http://www.hprcusa.com)

[info@hprc.it](mailto:info@hprc.it)