

plaber®

 READY

HPRC READY MADE SOLUTIONS -- 2023

We are HPRC. We don't just design and manufacture watertight hard protective cases, we supply carrying solutions. And solutions need to be no-hassle and tailored to your needs.

This is why in Autumn 2013 we designed our first case with a foam specially cut to house the DJI Phantom 1.

Now, almost 10 years later, we are a leading manufacturer of custom cases for drones, gimbals, camcorders and cameras but we feel we are still at the beginning: more is yet to come.

MADE IN ITALY

HPRC VECTOR PANEL

The new protective layer system designed for your Ready Case



Made of special PVC based compound, the Vector Panel ensures:

- foam long-last durability and integrity;
- improved protection for the equipment;
- dedicated item slots, suitably marked, avoiding lost tools;
- easy and quick organization of the case;
- savings in space and time;
- professional design and presentation.



The system significantly increases the overall performance and efficiency of the case in any kind of environment, weather conditions and temperature.



DJI

HPRC READY MADE SOLUTIONS – 2023

HPRC2400 for DJI Mavic 3 Cine / DJI Mavic 3 / DJI Mavic 3 Classic

MAV3-2400-01



- 1** DJI Mavic 3 Cine / DJI Mavic 3 / DJI Mavic 3 Classic
- 2** Battery Charging Hub / Cables
- 3** DJI RC Pro / DJI RC-N1 / DJI Smart Controllers
- 4** Propellers / Portable Charger
- 5** Miscellaneous
- 6** ND Filters Set 2X
- 7** Intelligent Flight Battery



HPRC MAVIC 3 CINE / DJI MAVIC 3 / DJI MAVIC 3 CLASSIC

TECHNICAL FEATURES

Dimension:
 Internal dimension
 377x263,9x150,8(mm) - 14.84x10.39x5.94(in)
 External dimension
 402x330,5x169,2(mm) - 15.83x13.01x6.66(in)

Weight:
 empty: 2,23kg - 4.92lbs
 with cubed foam: 2,58kg - 5.69lbs

Temperature rating:
 Minimum Maximum
 -40°C -40°F +80°C +176°F



TECHNICAL DRAWING

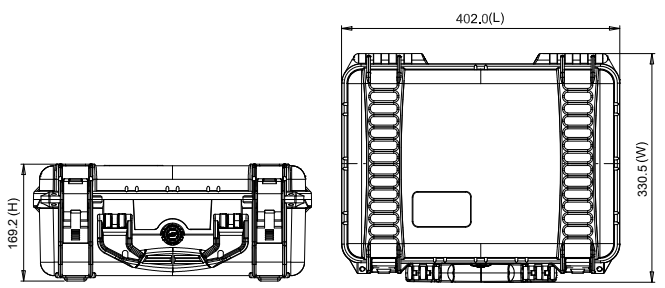

HPRC3500 for DJI Mavic 3 Cine / DJI Mavic 3 / DJI Mavic 3 Classic

MAV3-3500-01



- 1** DJI Mavic 3 Cine / DJI Mavic 3 / DJI Mavic 3 Classic
- 2** Battery Charging Hub / Cables
- 3** DJI RC Pro / DJI RC-N1 / DJI Smart Controllers
- 4** Propellers
- 5** Miscellaneous
- 6** ND Filters Set 2X
- 7** Intelligent Flight Battery



TECHNICAL FEATURES

Dimension:

Internal dimension
433,5x319,3x168,8(mm) - 17.07x12.57x6.65(in)
External dimension
497,9x370,3x184,9(mm) - 19.6x14.58x7.28(in)

Weight:

empty: 3,00kg - 6.61lbs
with cubed foam: 3,55kg - 7.82lbs

Temperature rating:

Minimum Maximum
-40°C -40°F +80°C +176°F



TECHNICAL DRAWING

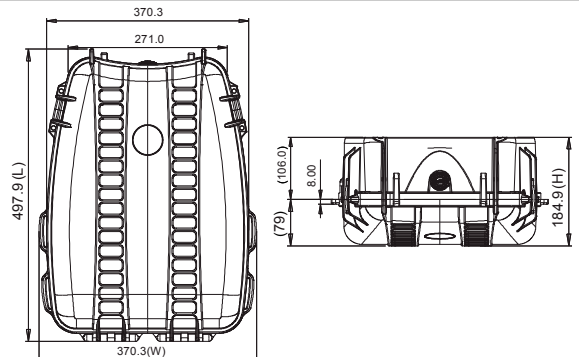

Bag for DJI Mavic 3 Cine / DJI Mavic 3

MAVBAG35-05

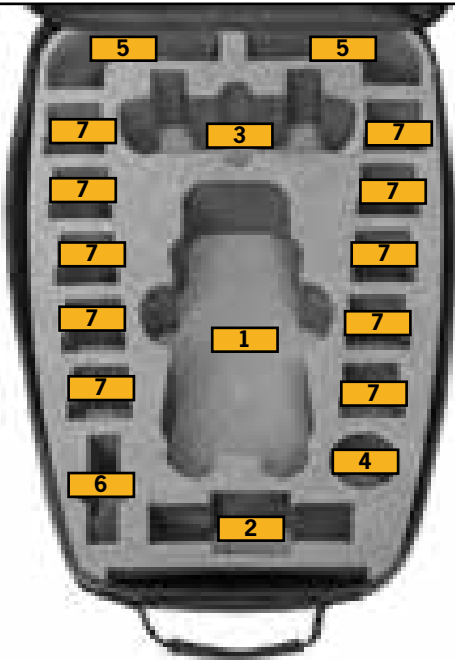

- 1** DJI Mavic 3 Cine / DJI Mavic 3
- 2** Battery Charging Hub / Cables
- 3** DJI RC Pro / DJI RC-N1 / DJI Smart Controllers
- 4** Propellers
- 5** Miscellaneous
- 6** ND Filters Set 2X
- 7** Intelligent Flight Battery



HPRC DJI MAVIC 3 / CINE

TECHNICAL FEATURES

Dimension:

internal dimension
433x319x169(mm) - 17.05x12.56x6.65(in)

external dimension
498x370x185(mm) - 19.61x14.57x7.28(in)



HPRC2700W for DJI Phantom 4RTK PHA4RTK-2700W-01



- 1 Dji Phantom 4 RTK / Multispectral
- 2 Intelligent Flight Battery
- 3 Remote Controller
- 4 Ipad Air/Tablet Up to 10"
- 5 Hprc1100 For 8 Microsd Cards
- 6 Charging Hub for WB37
- 7 Battery WB37
- 8 Charging Hub for Int.flight Battery
- 9 AC Power Adapter / Miscellaneous Accessories
- 10 Propellers



suitable for v 2.0 low noise propellers

TECHNICAL FEATURES

Dimension:

Internal dimension
554,7x458,7x246(mm) - 21.84x18.06x9.69(in)
External dimension
617,5x527,3x279,6(mm) - 24.31x20.76x11.0(in)

Weight:

empty: 7,75kg - 17.09lbs
with cubed foam: 9,07kg - 19.99lbs

Temperature rating:

Minimum Maximum
-40°C -40°F +80°C +176°F



TECHNICAL DRAWING

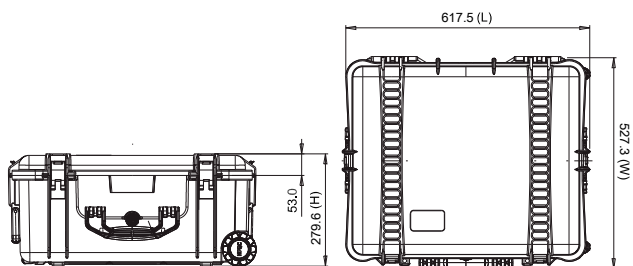

HPRC6500W for DJI D-RTK 2

DRTK6500W-01

dji
D-RTK 2



- 1** D-RTK 2 Body
- 2** Accessories Box (Mobile Phone Holder; Charging Hub, Intelligent Battery, Battery Cover, Ac Power Adapter\Cable etc)
- 3** Extention Rod
- 4** Tripod

TECHNICAL FEATURES

Dimension:

Internal dimension
1280,7x279x242,8(mm) - 50.42x10.98x9.56(in)
External dimension
1328x335x299,8(mm) - 52.28x13.19x11.8(in)

Weight:

empty: 7,2kg - 15.88lbs
with cubed foam: 9,03kg - 19.90lbs

Temperature rating:

Minimum Maximum
-40°C -40°F +80°C +176°F



TECHNICAL DRAWING

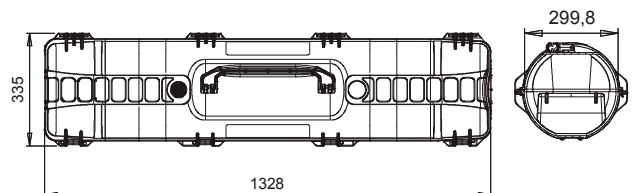

HPRC DJI D-RTK 2

HPRC5200R for DJI Matrice 30T

M30T-5200R-01

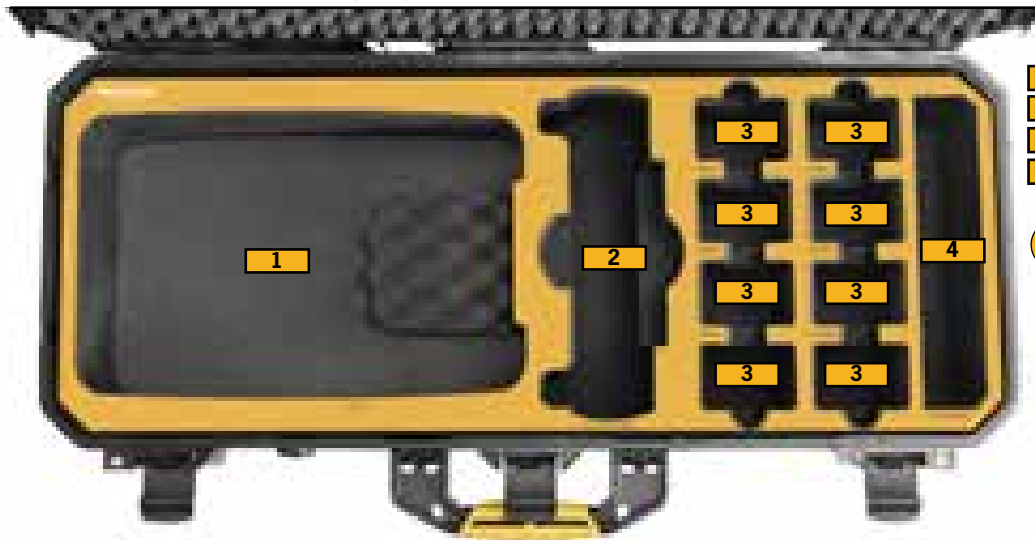

- 1** Aircraft Body
- 2** DJI RC Plus Remote Controller
- 3** TB30 Battery
- 4** Various/Miscellaneous



HPRC DJI MATRICE 30T

TECHNICAL FEATURES

Dimension:

Internal dimension
772x302x210(mm) - 30.39x11.89x8.26 (in)
External dimension
802x355x246.7(mm) - 31.57x13.97x9,71 (in)

Weight:

empty: 5.05kg – 11.1lbs

Temperature rating:

Minimum Maximum
-40°C -40°F +80°C +176°F



TECHNICAL DRAWING

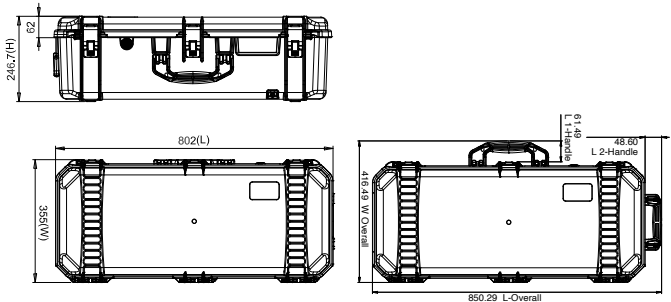

HPRC2760W for DJI Matrice 30T

M30T-2760W-01



- 1** WB37 Battery
- 2** TB30 Battery
- 3** DJI RC Plus Remote Controller
- 4** Aircraft Body
- 5** Loudspeaker
- 6** Miscellaneous



HPRC DJI MATRICE 30T

TECHNICAL FEATURES

Dimension:

Internal dimension
690x450x301(mm) - 27.16x17.72x11.85(in)
External dimension
750x511x329(mm) - 29.53x20.12x12.95(in)

Weight:

empty: 8,93kg - 19.69lbs
with cubed foam: 10,72kg - 23.63lbs

Temperature rating:

Minimum Maximum
-40°C -40°F +80°C +176°F



TECHNICAL DRAWING

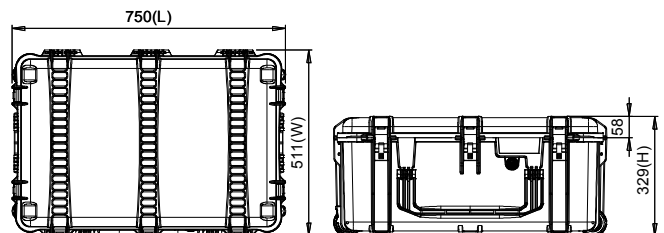

HPRC2700W for DJI Matrice 30T

M30T-2700W-01



- 1** Aircraft Body
- 2** Various/Miscellaneous
- 3** DJI RC Plus Remote Controller
- 4** Various/Miscellaneous
- 5** TB30 Battery



HPRC DJI MATRICE 30T

TECHNICAL FEATURES

Dimension:

Internal dimension
554,7x458,7x246(mm) - 21.84x18.06x9.69(in)
External dimension
617,5x527,3x279,6(mm) - 24.31x20.76x11.0(in)

Weight:

empty: 7,75kg - 17.09lbs
with cubed foam: 9,07kg - 19.99lbs

Temperature rating:

Minimum Maximum
-40°C -40°F +80°C +176°F



TECHNICAL DRAWING

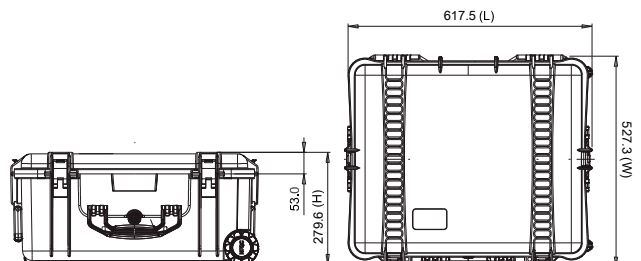

HPRC2460 for Batteries TB30 and DJI RC Plus BAT2460-01



- 1** DJI RC Plus Remote Controller
- 2** WB37 Battery
- 3** TB30 Battery



TECHNICAL FEATURES

Dimension:

Internal dimension
409x306x175(mm) - 16.10x12.05x6.89(in)
External dimension
435x377,8x193(mm) - 17.13x14.87x7.60(in)

Weight:

empty: 2,55kg - 5.62lbs
with foam: 3,14kg - 6.92lbs

Temperature rating:

Minimum Maximum
-40°C -40°F +80°C +176°F



TECHNICAL DRAWING

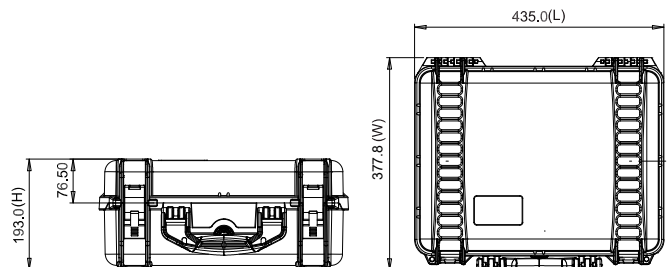

HPRC2800W for DJI Matrice 300 RTK

M300-2800W-03



LAY 1

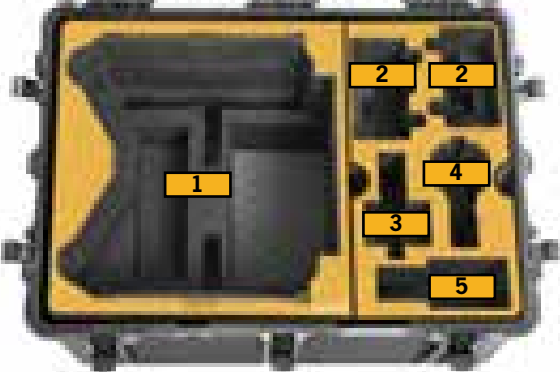

LAY 2

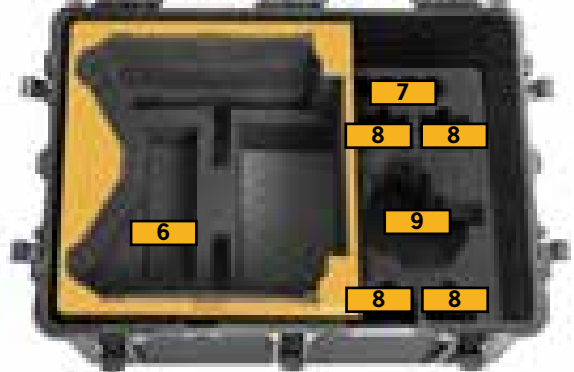

- 1** DJI Matrice 300 RTK in Landing Mode
(2 Gimbal and 2 Batteries mounted)
- 2** DJI Smart Controller Enterprise (Battery Attached)
- 3** Zenmuse L1
- 4** Zenmuse P1
- 5** H20/H20T Gimbal

- 6** Propellers
- 7** WB37 Intelligent Battery
- 8** TB60 Intelligent Flight Battery
- 9** Zenmuse H20N



TECHNICAL FEATURES

Dimension:

Internal dimension
748,6x524,6x454,6(mm) - 29.47x20.65x17.9(in)
External dimension
813,3x586,5x480,5(mm) - 32.02x23.09x18.92(in)

Weight:

empty: 13,25kg - 29.22lbs
with cubed foam: 17,43kg - 38.43lbs

Temperature rating:

Minimum Maximum
-40°C -40°F +80°C +176°F



TECHNICAL DRAWING

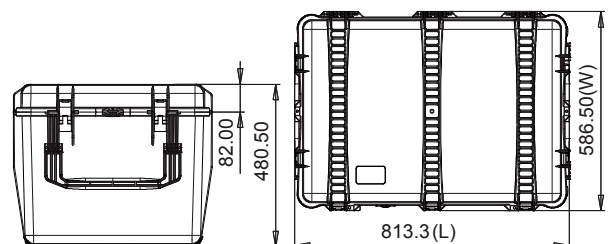

HPRC2550W for Battery DJI Matrice 300

BAT2550W-04

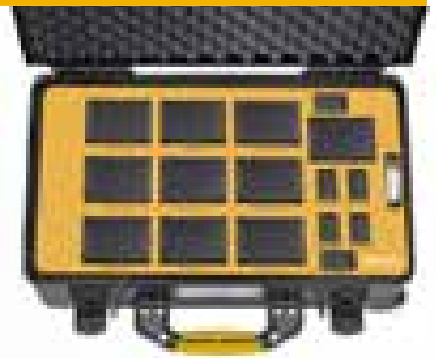

- 1** TB60 Intelligent Flight Battery
- 2** WB37 Intelligent Battery
- 3** Various/Perfect for Dry Keeper



HPRC DJI BATTERY CASES

TECHNICAL FEATURES

Dimension:

internal dimension
513x288x200(mm) - 20.19x11.34x7.87(in)
external dimension
549x346x236(mm) - 21.61x13.62x9.29(in)

Weight:

empty: 4.35kg - 9.57lbs

Temperature rating:

Minimum Maximum
-40°C -40°F +80°C +176°F



CABIN OK

TECHNICAL DRAWING

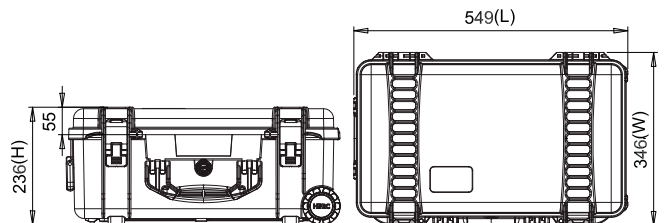

HPRC2300 for DJI Mini 3 Pro / DJI Mini 3 Fly More Combo with RC and RC-N1 Controller

MAVM-2300-03-01

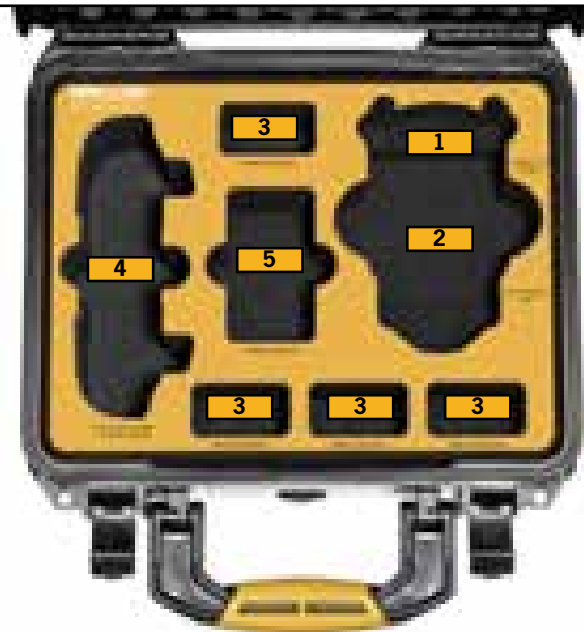
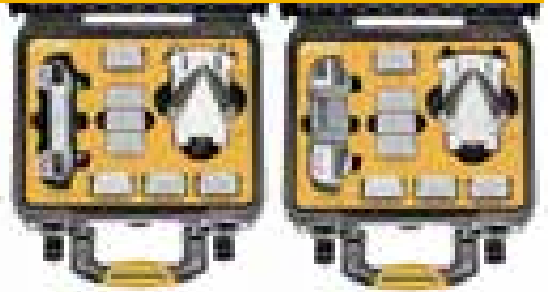

- 1** DJI Mini 3 Pro / DJI Mini 3 Fly More Combo
- 2** Spare Propellers/Cable
- 3** Intelligent Flight Battery
- 4** RC-N1 Remote Controller / RC Smart Controller
- 5** Two-Way Charging Hub



HPRC DJI MINI 3 PRO / DJI MINI 3

TECHNICAL FEATURES

Dimension:

Internal dimension
305,7x232,4x137,5(mm) - 12.04x9.15x5.41 (in)
External dimension
334,6x303x155,2(mm) - 13.17x11.93x6.11(in)

Weight:

empty: 1,75kg - 3.86lbs
with cubed foam: 1,90kg - 4.19lbs

Temperature rating:

Minimum Maximum
-40°C -40°F +80°C +176°F



TECHNICAL DRAWING

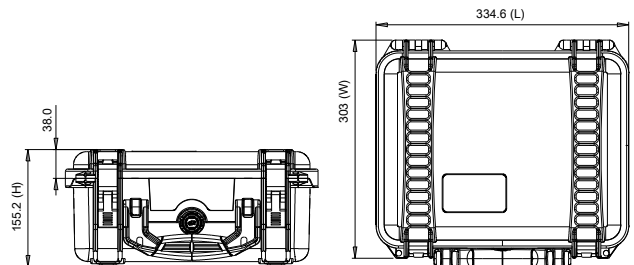

HPRC2400 for DJI Air 2S and Mavic Air 2

MAV2A-2400-02



- 1** DJI Air 2S and Mavic Air 2
- 2** Intelligent Flight Battery
- 3** Battery Charging Hub
- 4** Propellers
- 5** Battery to Power, Bank Adaptor
- 6** Nd Filter Set
- 7** Remote Controller/Smart controller
- 8** Battery Charger
- 9** Cable



HPRC DJI AIR 2 / AIR 2S

TECHNICAL FEATURES

Dimension:

Internal dimension
377x263,9x150,8(mm) - 14.84x10.39x5.94(in)

External dimension
402X330,5X169,2(mm) - 15.83x13.01x6.66(in)

Weight:

empty: 2.38 kg – 5.25 lbs
with foam: 2.49 kg -5.49 lbs

Temperature rating:

Minimum Maximum
-40°C -40°F +80°C +176°F



TECHNICAL DRAWING

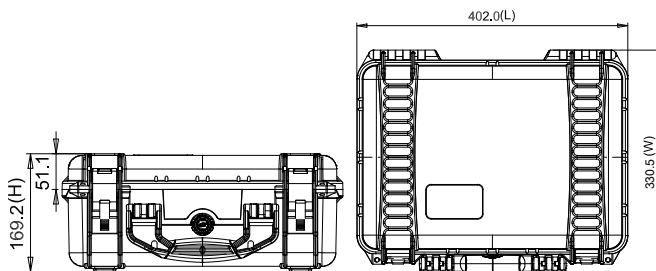

HPRC2300 for DJI Air 2S and Mavic Air 2 Fly More Combo

MAV2A-2300-02



- 1** DJI Air 2S and Mavic Air 2 Fly More Combo
- 2** Battery Charger
- 3** Intelligent Flight Battery
- 4** Remote Controller/Smart Controller
- 5** Propellers
- 6** Nd Filter Set
- 7** Cable



TECHNICAL FEATURES

Dimension:

Internal dimension
305,7x232,4x137,5(mm) - 12.04x9.15x5.41(in)
External dimension
334,6x303x155,2(mm) - 13.17x11.93x6.11(in)

Weight:

empty: 1,75 kg - 3.86 lbs
with foam: 1,88 kg - 4.13 lbs

Temperature rating:

Minimum Maximum
-40°C -40°F +80°C +176°F



TECHNICAL DRAWING

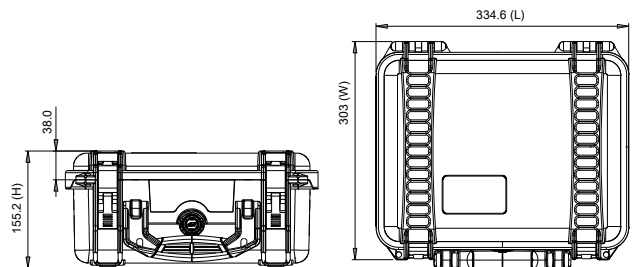

HPRC3500 for DJI Air 2S and Mavic Air 2 Fly More Combo

MAV2A-3500-01

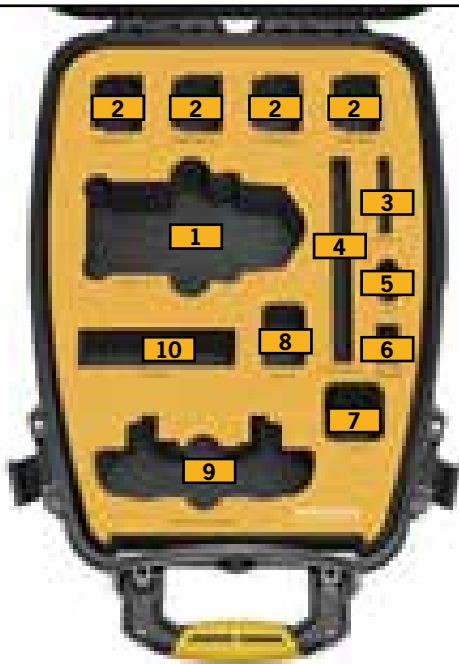

- 1** DJI Mavic Air 2 / Air 2S
- 2** Intelligent Flight Battery
- 3** Nd Filter Set
- 4** Battery Charging Hub
- 5** Cable
- 6** Battery to Power, Bank Adaptor
- 7** Propellers
- 8** Miscellaneous
- 9** Remote/Smart controller
- 10** Battery Charger



TECHNICAL FEATURES

Dimension:

internal dimension
433,5x319,3x168,8(mm) - 17.07x12.57x6.65(in)
external dimension
497,9x370,3x184,9(mm) - 19.6x14.58x7.28(in)

Weight:

empty: 3,00kg - 6.61lbs
with cubed foam: 3,55kg - 7.82lbs

Temperature rating:

Minimum Maximum
-40°C -40°F +80°C +176°F



TECHNICAL DRAWING

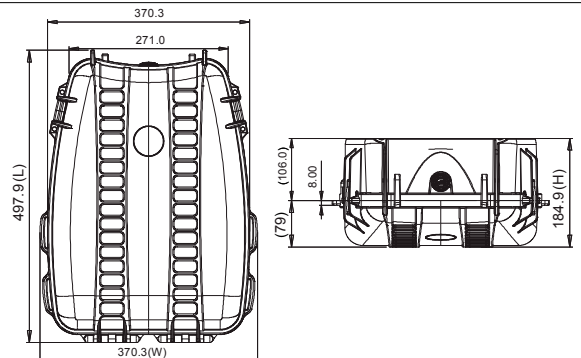

Bag for DJI Air 2S and Mavic Air 2 Fly More Combo

MAVBAG35-04

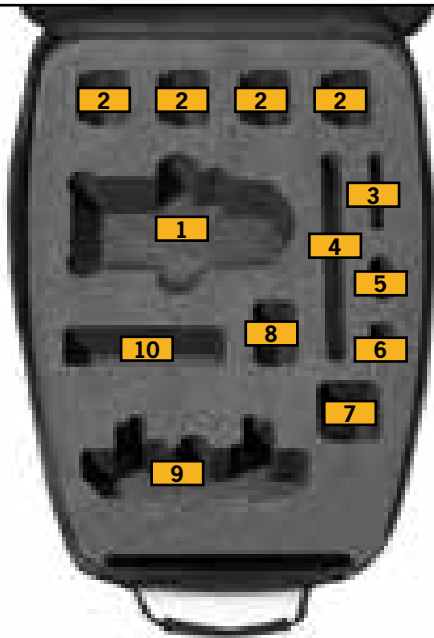

- 1** DJI Air 2S and Mavic Air 2 Fly More Combo
- 2** Intelligent Flight Battery
- 3** Nd Filter Set
- 4** Battery Charging Hub
- 5** Cable
- 6** Battery to Power, Bank Adaptor
- 7** Propellers
- 8** Miscellaneous
- 9** Remote Controller/Smart Controller
- 10** Battery Charger

TECHNICAL FEATURES

Dimension:

internal dimension
433x319x169(mm) - 17.05x12.56x6.65(in)
external dimension
498x370x185(mm) - 19.61x14.57x7.28(in)



HPRC2500 for DJI Avata Pro - View Combo

AVAT-2500-01



- 1** DJI Avata
- 2** Battery Charging Hub
- 3** Cable/Miscellaneous
- 4** Intelligent Flight Battery
- 5** Goggles 2 Battery
- 6** Goggles 2
- 7** Cable/Miscellaneous
- 8** Controller
- 9** Power Adapter
- 10** Eyeglass Frames (Pair)
- 11** Motion Controller



HPRC DJI AVATA PRO

TECHNICAL FEATURES

Dimension:

Internal dimension:
449,8x322,9x174,9(mm) - 17.71x12.71x6.89(in)

External dimension:
478,1x389,4x194(mm) - 18.82x15.33x7.64(in)

Weight:

empty: 3,08kg - 6.79lbs
with cubed foam: 3,71kg - 8.18lbs

Temperature rating:

Minimum Maximum
-40°C -40°F +80°C +176°F



TECHNICAL DRAWING

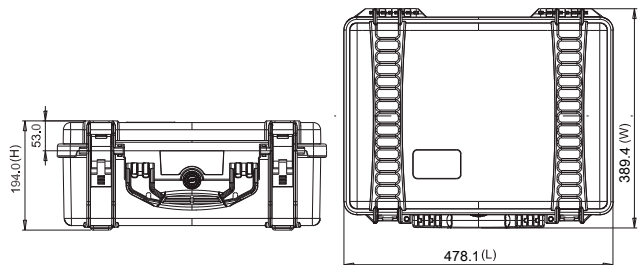

HPRC3500 for DJI Avata Pro - View Combo

AVAT-3500-01



- 1** DJI Avata
- 2** Cable/Miscellaneous
- 3** Battery Charging Hub
- 4** Goggles 2
- 5** Intelligent Flight Battery
- 6** Eyeglass Frames (Pair)
- 7** Controller
- 8** Cable/Miscellaneous
- 9** Power Adapter
- 10** Goggles 2 Battery
- 11** Motion Controller



HPRC DJI AVATA PRO

TECHNICAL FEATURES

Dimension:

Internal dimension: 433,5x319,3x168,8(mm) - 17.07x12.57x6.65(in)

External dimension:

497,9x370,3x184,9(mm) - 19.6x14.58x7.28(in)

Weight:

empty: 3,00kg - 6.61lbs

with cubed foam: 3,55kg - 7.82lbs

Temperature rating:

Minimum

Maximum

-40°C -40°F

+80°C +176°F



TECHNICAL DRAWING

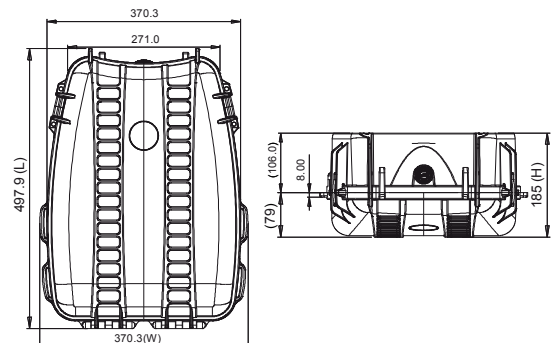

HPRC2500 for DJI FPV Combo

FPV-2500-01



- 1** DJI FPV Drone
- 2** Goggles Battery
- 3** Fly More kit
- 4** Goggles V2 with Goggles Antenna (or TrueRC) mounted
- 5** Remote Controller
- 6** Motion Controller
- 7** AC Power Adaptor
- 8** Intelligent Flight Battery
- 9** Propellers (Pair)/Cable



HPRC DJI FPV DRONE

TECHNICAL FEATURES

Dimension:
 internal dimension
 449,8x322,9x174,9(mm) - 17.71x12.71x6.89(in)
 external dimension
 478,1x389,4x194(mm) - 18.82x15.33x7.64(in)

Weight:
 empty: 3,22kg - 7.10lbs
 with cubed foam: 3,69kg - 8.12lbs

Temperature rating:
 Minimum Maximum
 -40°C -40°F +80°C +176°F



TECHNICAL DRAWING

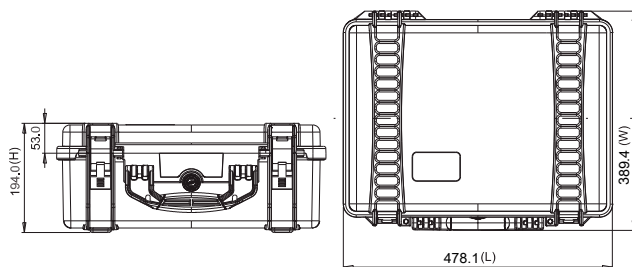

HPRC3600 for DJI FPV Combo

FPV-3600-01



- 1** DJI FPV Drone
- 2** Goggles Battery
- 3** Intelligent Flight Battery
- 4** AC Power Adaptor
- 5** Fly More kit
- 6** Propellers (Pair)/Cable
- 7** Miscellaneous/Motion Controller
- 8** Miscellaneous
- 9** Remote Controller
- 10** Goggles V2 with Goggles Antenna (or TrueRC) mounted



HPRC DJI FPV DRONE

TECHNICAL FEATURES

Dimension:

Internal dimension
479x354x194(mm) - 18.86x13.94x7.64(in)
External dimension
542x402x220(mm) - 21.34x15.83x8.66(in)



Weight:

empty: 3,23 kg - 7,11 lbs
with foam: 3,75 kg - 8,26 lbs

Temperature rating:

Minimum Maximum
-40°C -40°F +80°C +176°F

TECHNICAL DRAWING

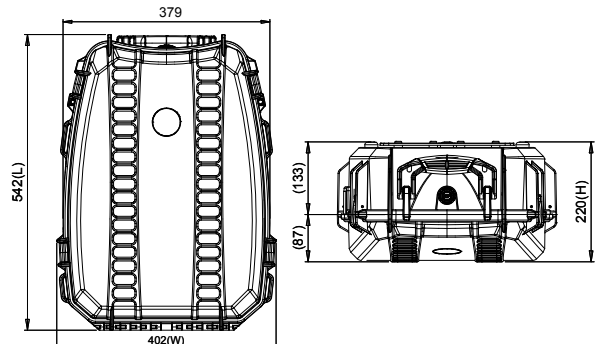

HPRC2710 for DJI Phantom 4

PHA4-2710-02

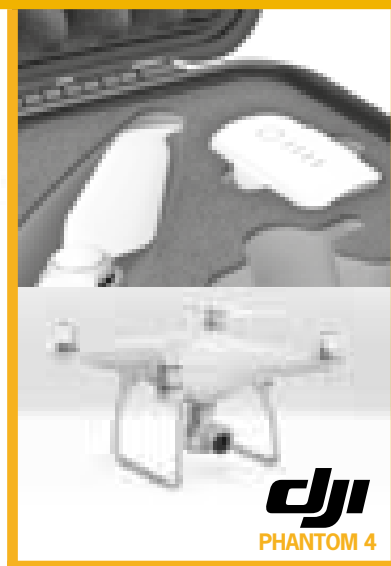

- 1** DJI Phantom 4 / Pro / 4 Pro + with Props On / 4 V2.0
- 2** Cables / Miscellaneous
- 3** 3 x Filters
- 4** Charger + Cables
- 5** 2 x Kits of Spare Props
- 6** Spare Battery
- 7** Spare Battery / Miscellaneous Accessories
- 8** Complimentary HPRC1100 for 8 MicroSD Cards
- 9** Ipad Air / Tablet up to 10"
- 10** Controller Monitor Hood for Tablets / Instructions
- 11** Remote Controller
- 12** Cables
- 13** Small Tools

suitable for v 2.0 low noise propellers

TECHNICAL FEATURES

Dimension:

Internal dimension
555x459x256(mm) - 21.85x18.07x10.08(in)
External dimension
617x525x280(mm) - 24.29x20.67x11.02(in)



Weight:

empty: 6.71kg - 14.76lbs

Temperature rating:

Minimum Maximum
-40°C -40°F +80°C +176°F

TECHNICAL DRAWING

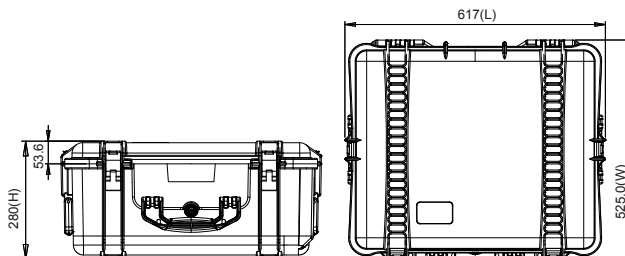

Bag for DJI Phantom 4

PHA4-BAG27-02



HPRC DJI PHANTOM 4

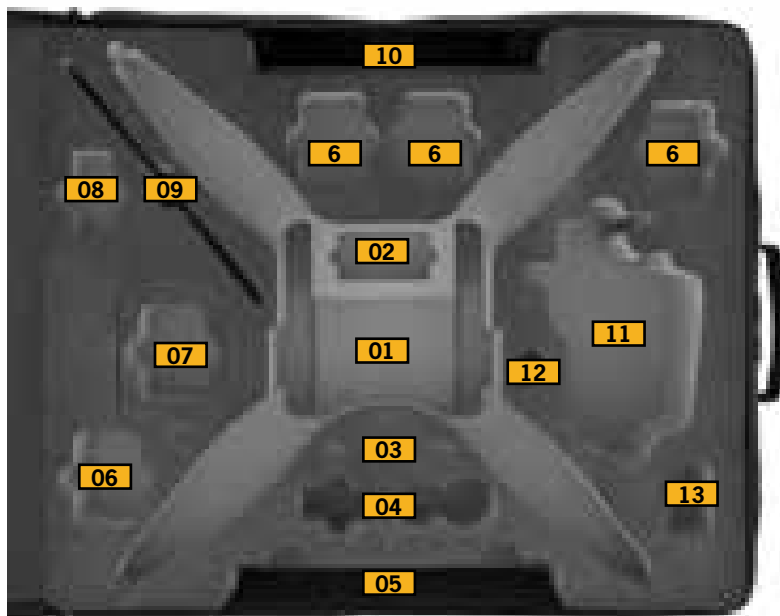

- 1** DJI Phantom 4 / Pro / 4 Pro + with Props On / 4 V2.0
- 2** Cables / Miscellaneous
- 3** 3 x Filters
- 4** Charger + Cables
- 5** 2 x Kits of Spare Props
- 6** Spare Battery
- 7** Spare Battery / Miscellaneous Accessories
- 8** Complimentary HPRC1100 for 8 MicroSD Cards
- 9** Ipad Air / Tablet up to 10"
- 10** Controller Monitor Hood for Tablets / Instructions
- 11** Remote Controller
- 12** Cables
- 13** Small Tools

suitable for v 2.0 low noise propellers

Dimension: external dimension
560x470x235(mm) - 22.05x18.50x9.25(in)

Weight:
empty: 7,70 kg - 16,98 lbs
with foam: 8,72 kg - 19,21 lbs

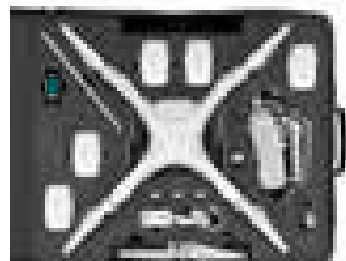

HPRC2780W for DJI Inspire 2

INS2-2780W-02

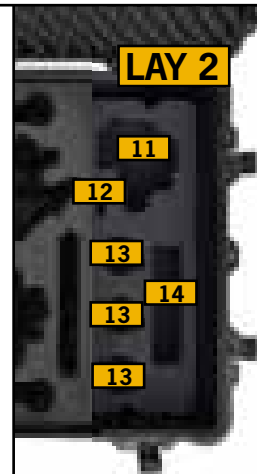
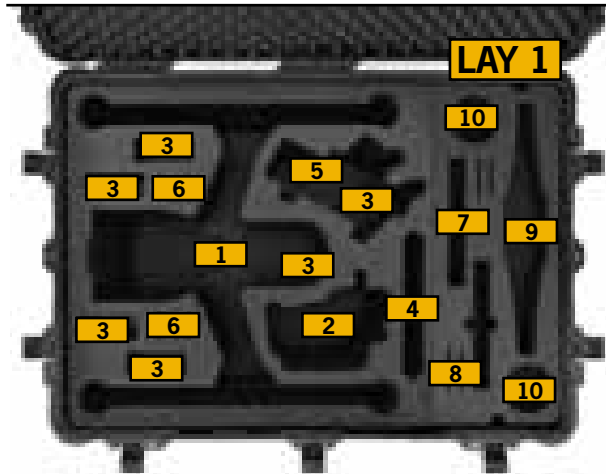
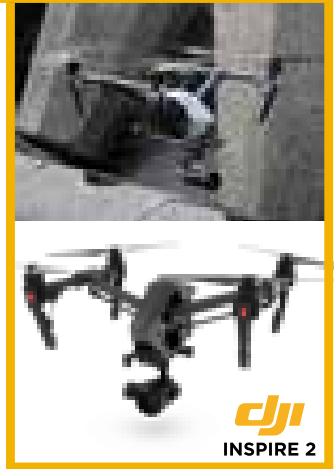

- 1** DJI Inspire 2 in Landing Mode with Gimbal X7 Attached
- 2** Transmitter (Radio Controller)
- 3** Spare Flight Battery
- 4** Crystal Monitor 7.85"
- 5** Cendence Remote Controller
- 6** SSD
- 7** Charger
- 8** Filters
- 9** Props + Spare Props
- 10** Charging Hub

- 11** Gimbal
- 12** Gimbal's Lid
- 13** Lens
- 14** Cables / Miscellaneous

- 15** Miscellaneous / Small Accessories

TECHNICAL FEATURES

Dimension:

Internal dimension
748,6x524,6x363,3(mm) - 29.47x20.65x14.3(in)
External dimension
814x586,5x387,7(mm) - 32.05x23.09x15.27(in)



Weight:

empty: 12,22kg - 26,94lbs
with cubed foam: 14,63kg - 32,24lbs

Temperature rating:

Minimum Maximum
-40°C -40°F +80°C +176°F

TECHNICAL DRAWING

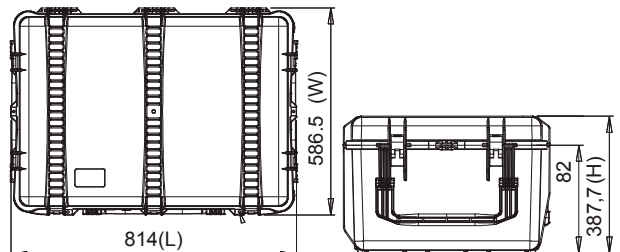

HPRC2800W for DJI Matrice 600 or Matrice 600 PRO

M600-2800W-01



- 1** DJI Matrice 600 // Matrice 600 Pro (Batteries TB47S Attached)
- 2** Hex Charger
- 3** Remote Controller
- 4** Landing Gear
- 5** Cable
- 6** Landing Gear



HPRC DJI MATRICE 600 | 600 PRO

TECHNICAL FEATURES

Dimension:

Internal dimension
748,6x524,6x454,6(mm) - 29.47x20.65x17.9(in)
External dimension
813,3x586,5x480,5(mm) - 32.02x23.9x18.92(in)

Weight:

empty: 13,20 kg - 29.10 lbs
with foam: 15,31 kg - 33.75 lbs

Temperature rating:

Minimum Maximum
-40°C -40°F +80°C +176°F



TECHNICAL DRAWING

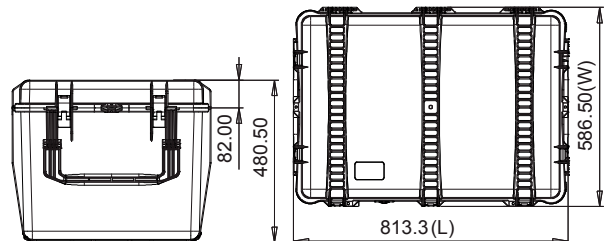

⌘ READY



HPRC4600W for DJI Matrice 200/210 v.2.0

M210-4600W-04

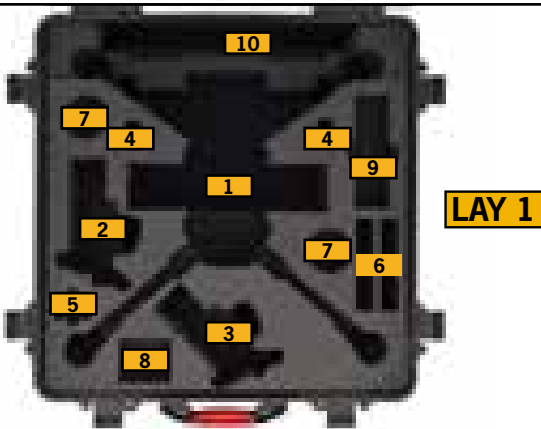

LAY 1

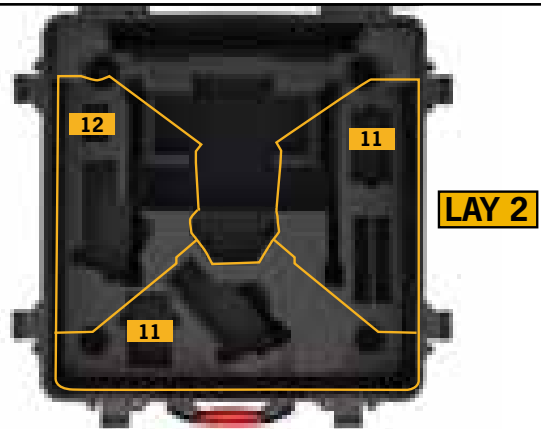

LAY 2

- 1** DJI Matrice 200/210 v.2.0 with 1 Gimbal Connector, 2 cameras, 2 GPS kit, 2 batteries TB55 mounted
- 2** Cendence Remote Controller
- 3** Cendence Remote Controller
- 4** CrystalSky Battery (WB37)
- 5** Charging Hub for CrystalSky (WCH2)
- 6** CrystalSky 7.85" with sun hood mounted
- 7** Charging Hub (IN2)
- 8** x 1 battery TB55
- 9** Battery Charger
- 10** x 4 Propellers Air

- 11** x 1 battery TB55
- 12** Small Accessories



TECHNICAL FEATURES

Dimension:
 internal dimension
 611x611x375(mm) - 24.05x24.05x14.76(in)
 external dimension
 670x677x418.5(mm) - 26.38x26.65x16.48(in)

Weight:
 empty: 9,9kg - 21.83lbs

Temperature rating:
 Minimum Maximum
 -40°C -40°F +80°C +176°F



TECHNICAL DRAWING

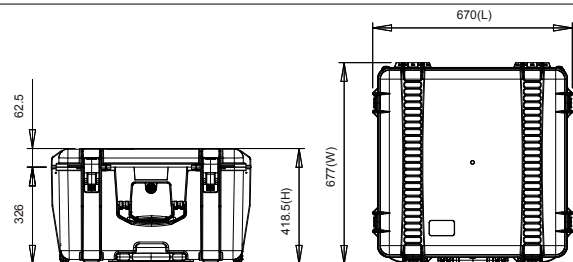

HPRC2730W for DJI Ronin 4D-6K Combo

R4D-2730W-01



- 1** DJI Ronin 4D Mounted
- 2** Charger
- 3** Lens DL 24/35/50 mm F2.8 LS
- 4** DL Mount
- 5** MRW-G1.SYM (Sony)
- 6** DJI Prossd 1TB
- 7** Various/Miscellaneous
- 8** DJI High-Bright Remote Monitor
- 9** DJI Zenmuse X9 Counterweight
- 10** CF Express Type B
- 11** NP-F970 (Sony)
- 12** TB50 Intelligent Flight Battery
- 13** Various/Miscellaneous



HPRC DJI RONIN 4D-6K COMBO

TECHNICAL FEATURES

Dimension:

Internal dimension
503x459x316(mm) - 19.80x18.07x12.44(in)

External dimension
616,9x531x349,6(mm) - 24.29x20.91x13.76(in)

Weight:

empty: 8,41kg - 18.54lbs
with cubed foam: 10,43kg - 22.99lbs

Temperature rating:

Minimum Maximum
-40°C -40°F +80°C +176°F



TECHNICAL DRAWING

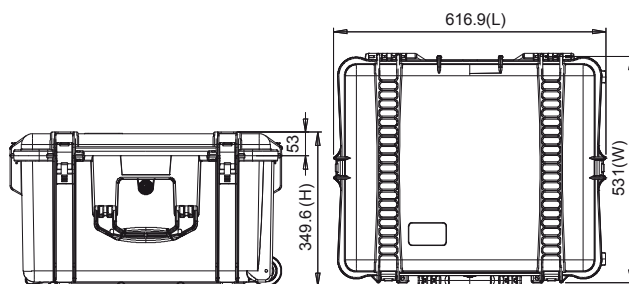

HPRC2300 for DJI Smart Controller Enterprise

SCE-2300-01



- 1** DJI Smart Controller Enterprise
- 2** Miscellaneous
- 3** Wb37 Intelligent Battery



HPRC DJI SMART CONTROLLER

TECHNICAL FEATURES

Dimension:

Internal dimension
305,7x232,4x137,5(mm) - 12.04x9.15x5.41(in)
External dimension
334,6x303x155,2(mm) - 13.17x11.93x6.11(in)



Weight:

empty: 1,75kg - 3.86lbs

Temperature rating:

Minimum Maximum
-40°C -40°F +80°C +176°F

TECHNICAL DRAWING

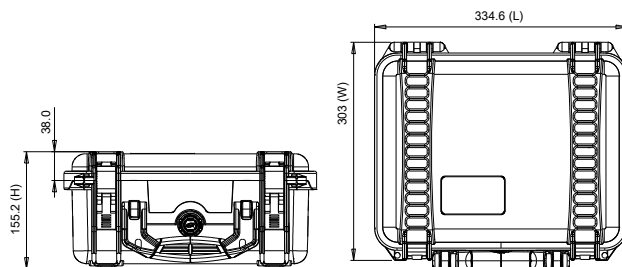

HPRC1400 for DJI Action 2 Dual-Screen Combo ACT2-1400-01



- 1** DJI Action 2 with Ball-Joint Adapter Mount
- 2** Rear Touchscreen Display with Magnetic Adapter Mount
- 3** Magnetic Lanyard
- 4** Magnetic Support
- 5** Power Cable



HPRC DJI ACTION 2 DUAL-SCREEN COMBO

TECHNICAL FEATURES

Dimension:

Internal dimension
180x110x40(mm) - 7.08x4.33x1.57(in)
External dimension
200,3x142,4x48(mm) - 7.89x5.61x1.89(in)



Weight:

empty: 0,26kg - 0,57lbs

Temperature rating:

Minimum Maximum
-40°C -40°F +80°C +176°F

TECHNICAL DRAWING

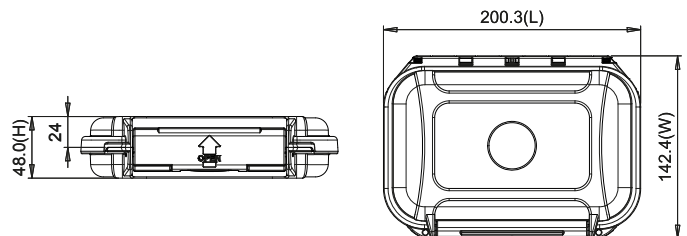

HPRC 1400 for DJI Pocket 2 Creative Combo Kit OSMPKT-1400-02



- 1** DJI Pocket 2 with 1/4"-20 Tripod Mounted
- 2** Micro Tripod
- 3** Mini Control Stick
- 4** Cable/Wireless Microphone Windscreen
- 5** Do-it-All Handle
- 6** Wireless Microphone Transmitter/SD Card
- 7** Wide-Angle Lens
- 8** Lightning (iOS) Smartphone Adapter/ USB Type-C Smartphone Adapter



TECHNICAL FEATURES

Dimension:

internal dimension
180x110x40(mm) - 7.08x4.33x1.57(in)
external dimension
200,3x142,4x48(mm) - 7.89x5.61x1.89(in)

Weight:

empty: 0,26kg - 0.57lbs

Temperature rating:

Minimum Maximum
-40°C -40°F +80°C +176°F



TECHNICAL DRAWING

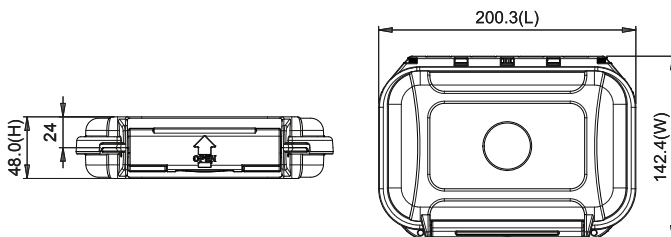

HPRC2600 for DJI RS 3 Pro Combo

RS3-2600-01

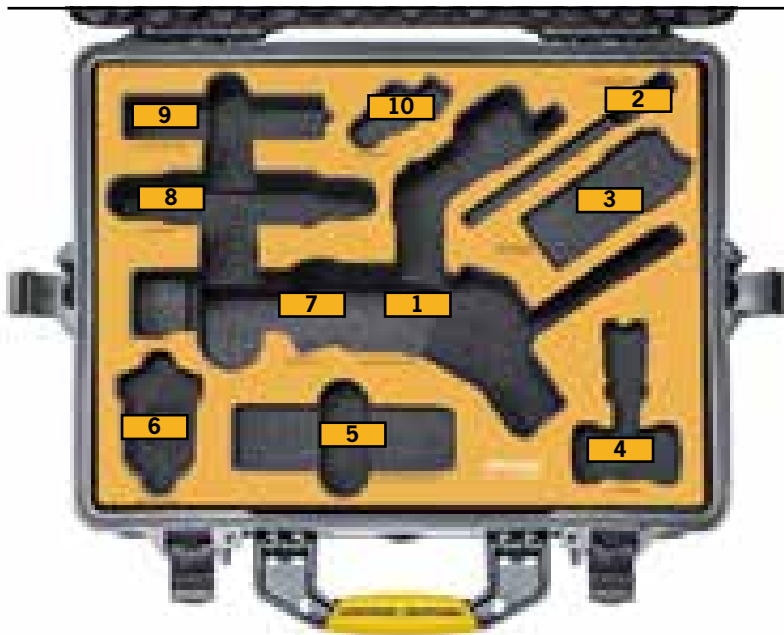

- 1** Gimbal with BG30 Grip mounted
- 2** Focus Motor Rod Mount Kit Combo
- 3** Quick-Release Plate (Arca-Swiss/Manfrotto)
- 4** Phone Holder
- 5** Lower Quick-Release Plate (Extended)
- 6** Ronin Image Transmitter
- 7** Cable/Miscellaneous
- 8** Briefcase Handle
- 9** Extended Grip/Tripod (Metal)
- 10** Focus Motor (2022)



HPRC DJI RS 3 PRO COMBO

TECHNICAL FEATURES

Dimension:

Internal dimension

482,4x358,3x198,1(mm) - 18.99x14.10x7.80(in)

External dimension

543,4x426,8x218,1(mm) - 21.39x16.8x8.59(in)

Weight:

empty: 4,25kg - 9,37lbs

with cubed foam: 5,05kg - 11.13lbs

Temperature rating:

Minimum

-40°C -40°F

Maximum

+80°C +176°F



TECHNICAL DRAWING

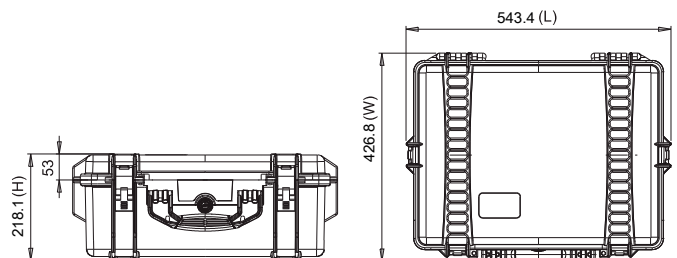

HPRC2500 for DJI RS 2 Pro Combo

RS2-2500-01



- 1 Gimbal
- 2 Cable/Miscellaneous
- 3 Briefcase Handle
- 4 Phone Holder
- 5 Image Transmitter
- 6 Quick-Release Plate (Arca-Swiss/Manfrotto)
- 7 Focus Motor
- 8 BG30 Grip
- 9 Extended Grip/Tripod (Metal)



HPRC DJI RS 2 PRO COMBO

TECHNICAL FEATURES

Dimension:

internal dimension
449,8x322,9x174,9(mm) - 17.71x12.71x6.89(in)
external dimension
478,1x389,4x194(mm) - 18.82x15.33x7.64(in)

Weight:

empty: 3,22kg - 7.10lbs
with cubed foam: 3,79kg - 8.34lbs

Temperature rating:

Minimum Maximum
-40°C -40°F +80°C +176°F



TECHNICAL DRAWING

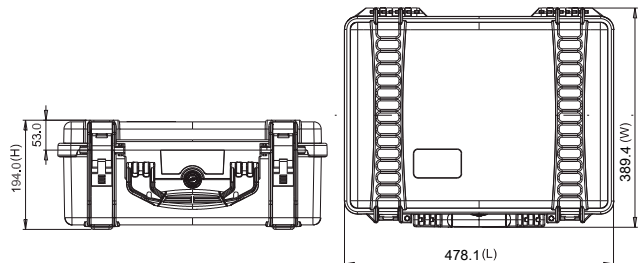

HPRC3500 for DJI RS 2 Pro Combo

RS2-3500-01



- 1** Gimbal
- 2** Cable/Miscellaneous
- 3** Quick-Release Plate (Arca-Swiss/Manfrotto)
- 4** Briefcase Handle
- 5** BG30 Grip/ Extended Grip/Tripod (Metal)
- 6** Phone Holder
- 7** Cable/Miscellaneous



TECHNICAL FEATURES

Dimension:

internal dimension
433x319x168,8(mm) - 17.07x12.57x6.65(in)
external dimension
497,9x370,3x184,9(mm) - 19.6x14.58x7.28(in)

Weight:

empty: 3,00kg - 6.61lbs
with cubed foam: 3,55kg - 7.82lbs

Temperature rating:

Minimum Maximum
-40°C -40°F +80°C +176°F



TECHNICAL DRAWING

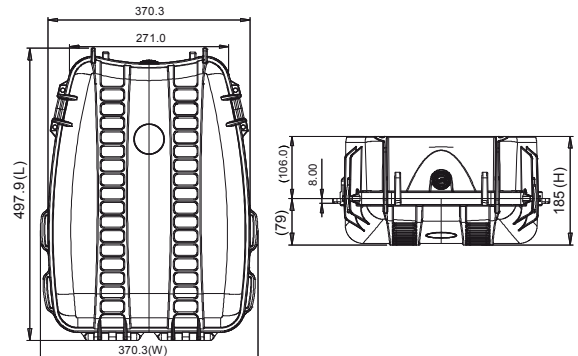

HPRC Bag for DJI RS 2 Pro Combo

RS2-BAG35-01

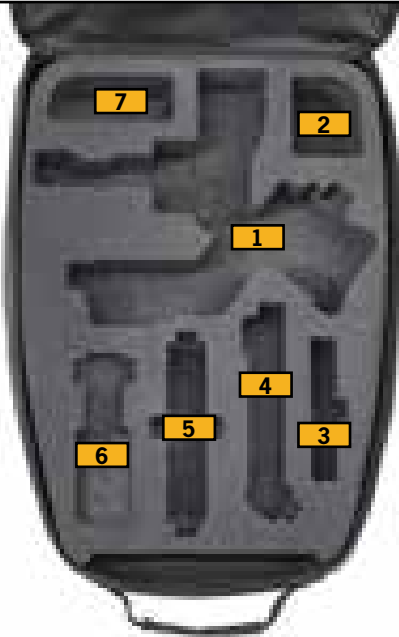

- 1** Gimbal
- 2** Cable/Miscellaneous
- 3** Quick-Release Plate (Arca-Swiss/Manfrotto)
- 4** Briefcase Handle
- 5** BG30 Grip/ Extended Grip/Tripod (Metal)
- 6** Phone Holder
- 7** Cable/Miscellaneous

TECHNICAL FEATURES

Dimension:

internal dimension
433x319x169(mm) - 17.05x12.56x6.65(in)
external dimension
498x370x185(mm) - 19.61x14.57x7.28(in)



HPRC2500 for DJI RSC 2 Pro Combo

RSC2-2500-01

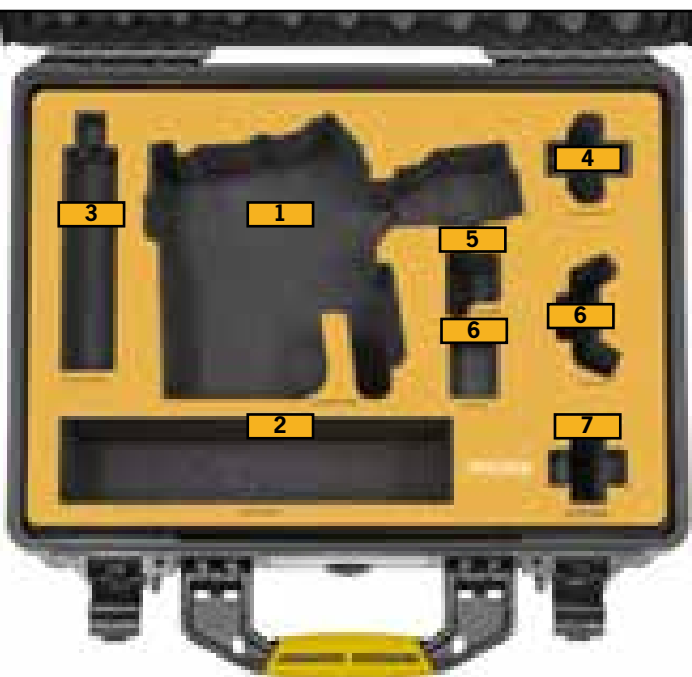

- 1** Gimbal (Built-In Battery)
- 2** Cable/Miscellaneous
- 3** Extended Grip/Tripod
- 4** Image Transmitter
- 5** Focus Motor
- 6** Phone Holder
- 7** Quick-Release Plate (Arca-Swiss/Manfrotto)



HPRC DJI RSC 2 PRO COMBO

TECHNICAL FEATURES

Dimension:

internal dimension
449,8x322,9x174,9(mm) - 17.71x12.71x6.89(in)
external dimension
478,1x389,4x194(mm) - 18.82x15.33x7.64(in)

Weight:

empty: 3,22kg - 7.10lbs
with cubed foam: 3,78kg - 8.33lbs

Temperature rating:

Minimum Maximum
-40°C -40°F +80°C +176°F



TECHNICAL DRAWING

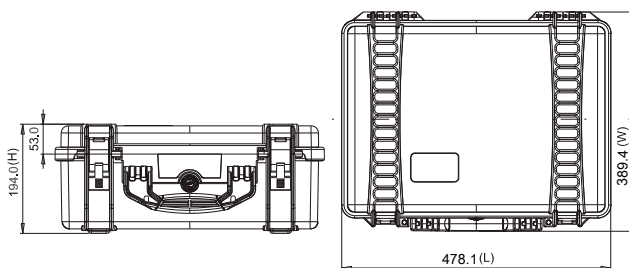



AUTEL ROBOTICS



HPRC READY MADE SOLUTIONS – 2023

HPRC2460 for Autel Robotics EVO Lite+ Premium Bundle

LITE-2460-01



- 1** Aircraft (including battery, propellers and gimbal cover)
- 2** Multi-Charger
- 3** Spare Propellers
- 4** Power Adapter
- 5** Cable
- 6** Spare Battery
- 7** Remote Control
- 8** Filter Set
- 9** Usb Cable



TECHNICAL FEATURES

Dimension:

Internal dimension
409x306x175(mm) - 16.10x12.05x6.89(in)
External dimension
435x377,8x193(mm) - 17.13x14.87x7.60(in)

Weight:

empty: 2,55kg - 5.62lbs
with cubed foam: 3,14kg - 6.92lbs

Temperature rating:

Minimum Maximum
-40°C -40°F +80°C +176°F



TECHNICAL DRAWING

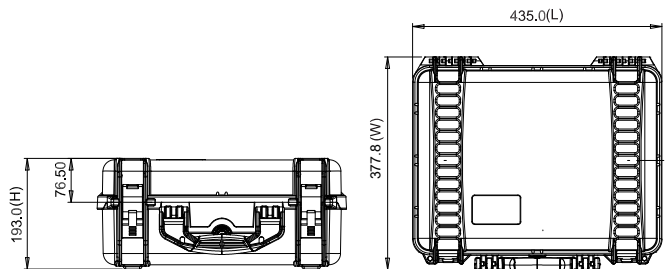

HPRC2300 for Autel Robotics Evo Nano+ Premium Bundle

NANO-2300-01



- 1** Autel EVO Nano+ including battery, propellers, gimbal cover and propeller holder
- 2** Spare Propellers
- 3** Spare Battery
- 4** Remote Control
- 5** Cables/Miscellaneous
- 6** Power Adapter
- 7** Multi-Charger



HPRC AUTEL ROBOTICS EVO NANO+

TECHNICAL FEATURES

Dimension:

Internal dimension
305,7x232,4x137,5(mm) - 12.04x9.15x5.41 (in)
External dimension
334,6x303x155,2(mm) - 13.17x11.93x6.11(in)



Weight:

empty: 1,70kg - 3.75lbs
with foam: 1,9kg - 4.19lbs

Temperature rating:

Minimum	Maximum
-40°C -40°F	+80°C +176°F

TECHNICAL DRAWING

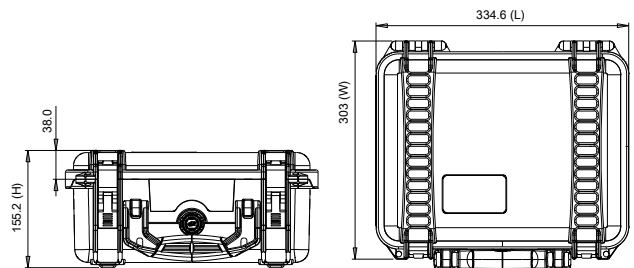

HPRC2400 Autel Robotics EVO II 6K / 8K Drone EVO2-2400-02



- 1** Autel Robotics EVO II 6K / 8K with propellers - low noise
- 2** Remote Controller
- 3** Battery Charging Hub
- 4** Flight Battery
- 5** Cable/Propellers/Accessories
- 6** Micro USB Cable
- 7** Charger



HPRC AUTEL ROBOTICS

TECHNICAL FEATURES

Dimension:

Internal dimension
377x263,9x150,8(mm) - 14.84x10.39x5.94(in)
External dimension
402x330,5x169,2(mm) - 15.83x13.01x6.66(in)

Weight:

empty: 2,38kg - 5.25lbs

Temperature rating:

Minimum Maximum
-40°C -40°F +80°C +176°F



TECHNICAL DRAWING

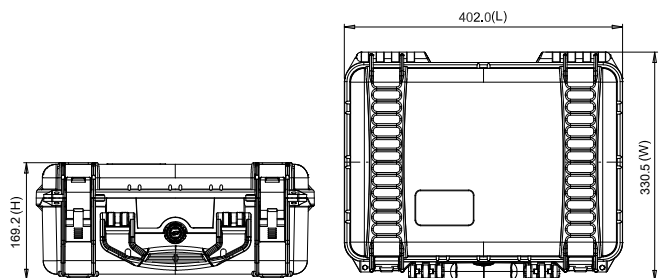



 2300
HPSC

ATOMOS

HPSC READY MADE SOLUTIONS – 2023

HPRC2300 for Atomos Ninja V

NJAV-2300-01

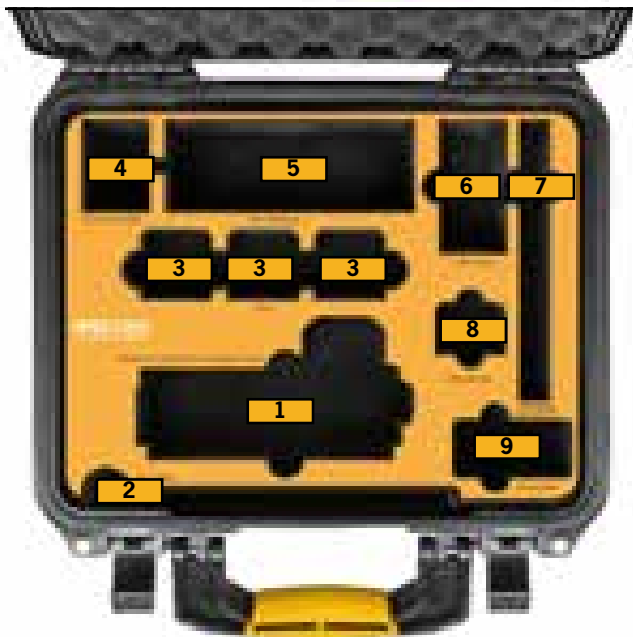

- 1** Ninja Atomos V with AtomX SSD mini and Battery mounted
- 2** Ninja V Sunhood
- 3** Battery
- 4** 12V-3A AC Power Supply
- 5** Cables/Miscellaneous
- 6** 3 Master Caddy II
- 7** Lector docking station USB-C 3.1
- 8** Battery Eliminator
- 9** Power kit Atomos



TECHNICAL FEATURES

Dimension:

Internal dimension
305,7x232,4x137,5(mm) - 12.04x9.15x5.41(in)
External dimension
334,6x303x155,2(mm) - 13.17x11.93x6.11(in)



Weight:

empty: 1,75kg - 3.86lbs
with cubed foam: 1,90kg - 4.19lbs

Temperature rating:

Minimum Maximum
-40°C -40°F +80°C +176°F

TECHNICAL DRAWING

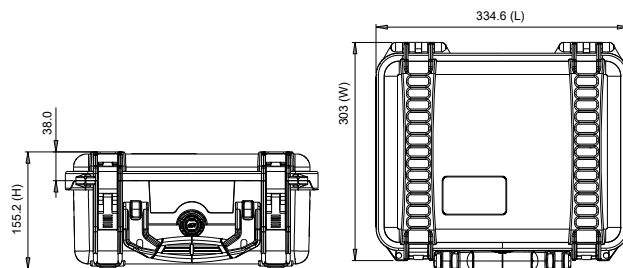

HPRC2400 Atomos Shogun 7 + Accessory Kit SHG7-2400-01

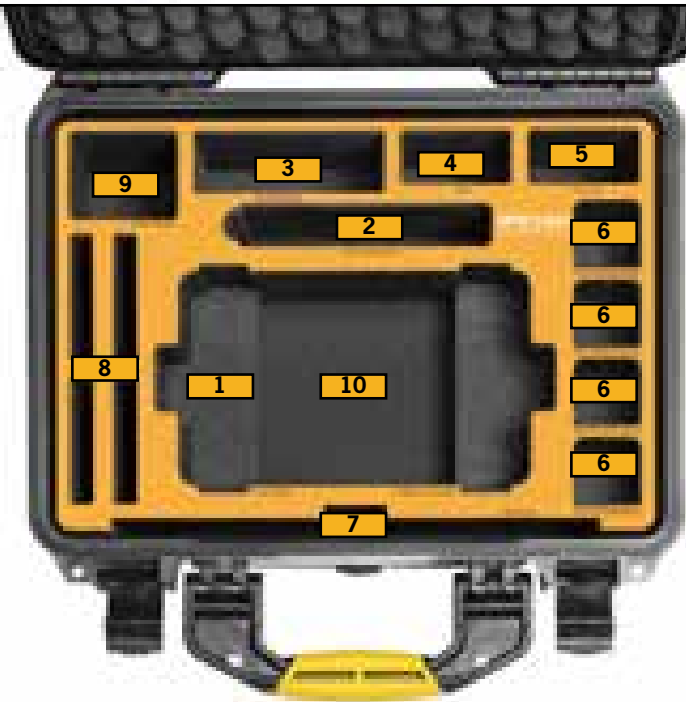

- 1** Atomos Shogun 7
- 2** USB 3.0 docking station
- 3** International Adapter
- 4** Cable
- 5** Fast charger
- 6** NP-F750 5200mAh Batteries
- 7** HDR Sunhood
- 8** Master Caddy II drive caddies
- 9** AC Power Adapter
- 10** Miscellaneous Accessories



HPRC ATOMOS SHOGUN 7

TECHNICAL FEATURES

Dimension:

Internal dimension
377x263,9x150,8(mm) - 14.84x10.39x5.94(in)
External dimension
402x330,5x169,2(mm) - 15.83x13.01x6.66(in)

Weight:

empty: 2,23kg - 4.91lbs
with cubed foam: 2,46kg - 5.42lbs

Temperature rating:

Minimum Maximum
-40°C -40°F +80°C +176°F



TECHNICAL DRAWING

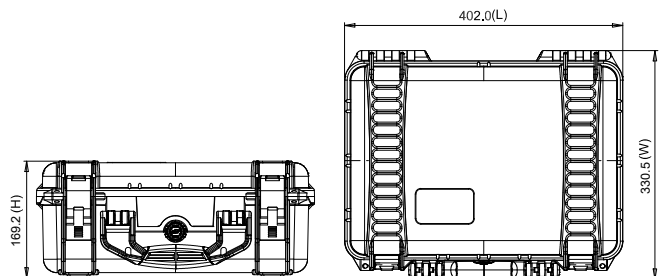

HPRC2730W for Atomos Sumo19

SM19-2730W-01



- 1** Atomos Sumo 19" Monitor Recorder
- 2** Atomos Sunhood



- 3** Charger
- 4** 3 Master caddy II
- 5** DM-130A Gold Mount Mini Battery or similar
- 6** D-4BA Battery Extender or similar

TECHNICAL FEATURES

Dimension:

internal dimension
503x459x316(mm) - 19.80x18.07x12.44(in)
external dimension
616,9x531x349,6(mm) - 24.29x20.91x13.76(in)

Weight:

empty: 8,41kg - 18.54lbs
with cubed foam: 10,43kg - 22.99lbs

Temperature rating:

Minimum Maximum
-40°C -40°F +80°C +176°F



TECHNICAL DRAWING

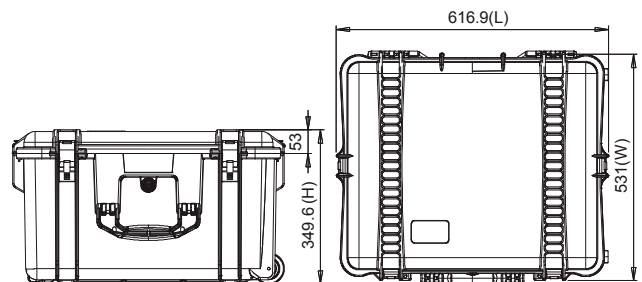



BLACKMAGIC

HPRC READY MADE SOLUTIONS – 2023

HPRC2400 for Blackmagic Pocket Cinema Camera 6K Pro

PKT6P-2400-01

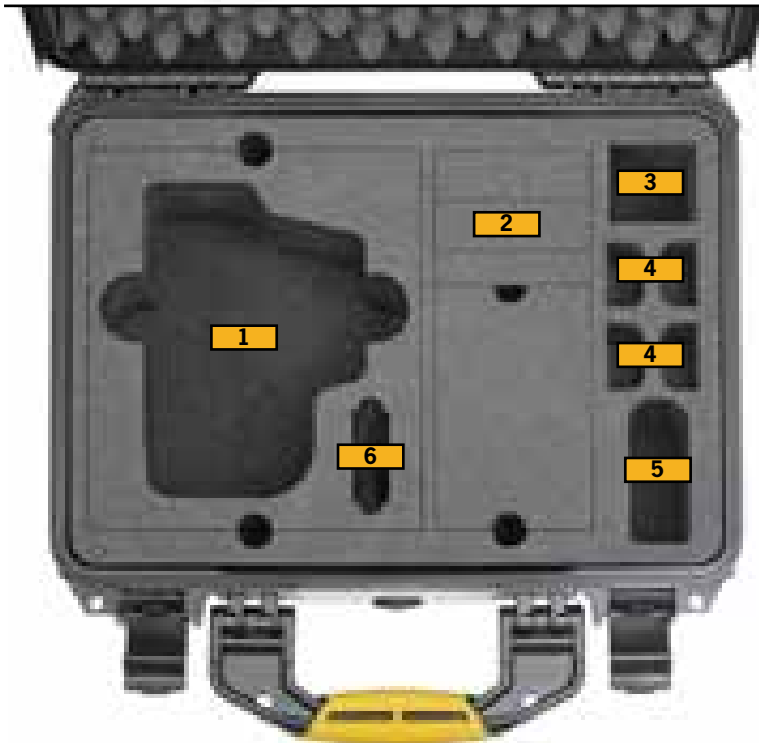

- 1** Blackmagic Pocket Cinema Camera 6K Pro with or without professional cage
- 2** Lenses: Diameter Max 90mm × Length Max 220mm
- 3** International Adapters
- 4** LP-E6 Battery
- 5** 30W power supply
- 6** HPRC1100MEM

HPRC BLACKMAGIC POCKET CAMERA 6K PRO

TECHNICAL FEATURES

Dimension:

Internal dimension
377x263,9x150,8(mm) - 14.84x10.39x5.94(in)
External dimension
402x330,5x169,2(mm) - 15.83x13.01x6.66(in)

Weight:

empty: 2,23kg - 4.91lbs
with cubed foam: 2,55kg - 5.62lbs

Temperature rating:

Minimum Maximum
-40°C -40°F +80°C +176°F



TECHNICAL DRAWING

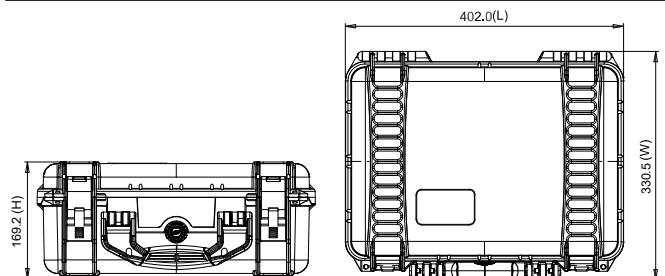

HPRC2400 COMBO for Blackmagic Pocket Cinema Camera 6K or 4K

PKTC-2400-01



- 1** Cinema Blackmagic Pocket 4K or 6K with or without professional cage and Metabones mounted
- 2** Lenses: Diameter Max 90mm x Length Max 220mm
- 3** International Adapters
- 4** LP-E6 Battery
- 5** 30W power supply
- 6** HPRC1100MEM

HPRC BLACKMAGIC POCKET CAMERA 6K OR 4K

TECHNICAL FEATURES

Dimension:

Internal dimension
377x263,9x150,8(mm) - 14.84x10.39x5.94(in)
External dimension
402x330,5x169,2(mm) - 15.83x13.01x6.66(in)

Weight:

empty: 2,23kg - 4.91lbs
with cubed foam: 2,55kg - 5.62lbs

Temperature rating:

Minimum	Maximum
-40°C -40°F	+80°C +176°F



TECHNICAL DRAWING

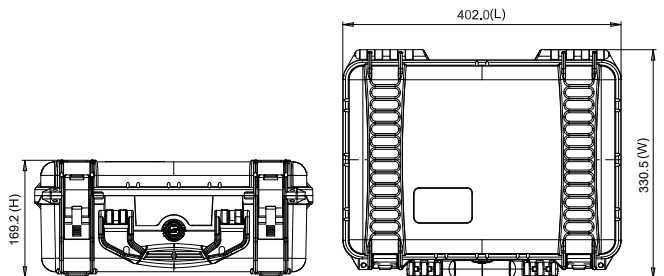

HPRC2300 for ATEM Mini, ATEM Mini Pro and ATEM Mini Pro ISO

AMI-2300-01



- 1** ATEM Mini/Mini Pro/Mini Pro ISO
- 2** Charger
- 3** Angelbird SSD2GO
- 4** Blackmagic ATEM Streaming Bridge
- 5** HDMI cables/Miscellaneous



HPRC ATEM MINI / PRO / PRO ISO

TECHNICAL FEATURES

Dimension:

Internal dimension
305,7x232,4x137,5(mm) - 12.04x9.15x5.41(in)
External dimension
334,6x303x155,2(mm) - 13.17x11.93x6.11(in)



Weight:

empty: 1,75kg - 3.86lbs
with cubed foam: 1,90kg - 4.19lbs

Temperature rating:

Minimum Maximum
-40°C -40°F +80°C +176°F

TECHNICAL DRAWING

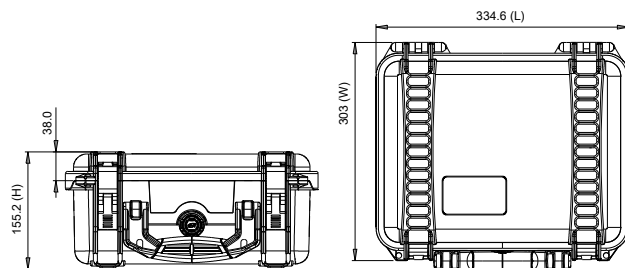

HPRC2500 for ATEM Mini Extreme and Atem Mini Extreme ISO

AME-2500-01



- 1** ATEM Mini Extreme/Mini Extreme ISO
- 2** Miscellaneous
- 3** Charger
- 4** Blackmagic ATEM Streaming Bridge
- 5** Angelbird SSD2GO
- 6** HDMI cables/Miscellaneous



HPRC ATEM MINI EXTREME / EXTREME ISO

TECHNICAL FEATURES

Dimension:

internal dimension
449,8x322,9x174,9(mm) - 17.71x12.71x6.89(in)
external dimension
478,1x389,4x194(mm) - 18.82x15.33x7.64(in)

Weight:

empty: 3,08kg - 6.79lbs
with cubed foam: 3,71kg - 8.18lbs

Temperature rating:

Minimum Maximum
-40°C -40°F +80°C +176°F



TECHNICAL DRAWING

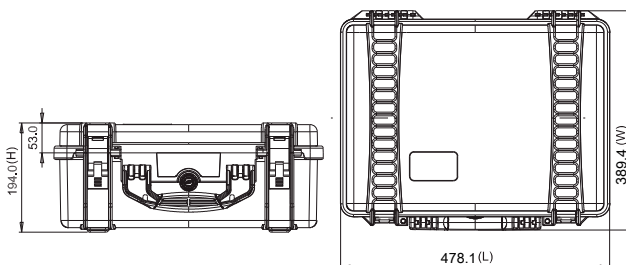

HPRC2710 for Blackmagic Atem 1 M/E

ADV1-2710-01



Blackmagicdesign



1 Blackmagic Design Atem 1 M/E Advanced Panel

TECHNICAL FEATURES

Dimension:
 internal dimension
 555x459x256(mm) - 21.85x18.07x10.08(in)
 external dimension
 617x525x280(mm) - 24.29x20.67x11.02(in)



Weight:
 empty: 6,43 kg - 14.18 lbs
 with foam: 7,45 kg - 16.42 lbs

Temperature rating:
 Minimum Maximum
 -40°C -40°F +80°C +176°F

TECHNICAL DRAWING

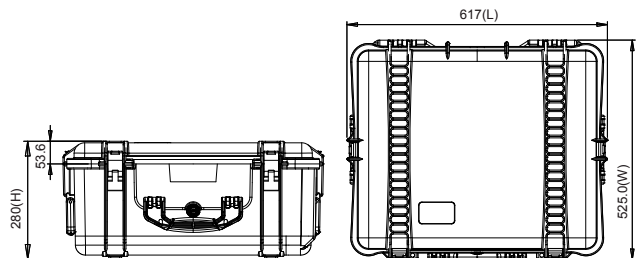

HPRC2730W for Blackmagic Ursa Mini Pro/Broadcast

URS2730W-03



Blackmagicdesign  FOR URSA MINI PRO and URSA BROADCAST



- 1** BlackMagic Ursa Mini Pro / Broadcast with shoulder pad and top handle mounted
- 2** Tripod Plate
- 3** Shoulder Mount kit - Rods clamps
- 4** Batteries
- 5** Lens
- 6** Accessories / Cables
- 7** HPRC1100 Memory card holder for CFast/SDHC cards
- 8** Charger standard and Charger SWIT S-3802S



TECHNICAL FEATURES

Dimension:

internal dimension
503x459x316(mm) - 19.80x18.07x12.44(in)
external dimension
616,9x531x349,6(mm) - 24.29x20.91x13.76(in)

Weight:

empty: 8,41kg - 18.54lbs
with cubed foam: 10,43kg - 22.99lbs

Temperature rating:

Minimum Maximum
-40°C -40°F +80°C +176°F



TECHNICAL DRAWING

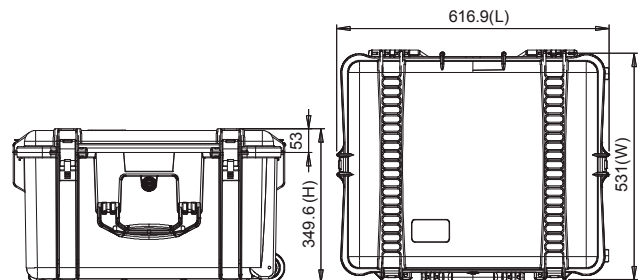





SONY

HPRC READY MADE SOLUTIONS – 2023

HPRC2460 for Sony Alpha 7

ALP2460-01



HPRC2460 for ALPHA 7 is a special edition, designed to safely carry your SONY Alpha Series.



- 1** Sony A7/A7R/A7S/A7II/A7RII/A7SII / A7SIII / a6300/ Alpha 1 with or without professional cage and lenses mounted (EF/F/PL-Mount/Leica R)
- 2** Lenses: Sony FE 50/1.4, 50/2,8 Macro, 24-70/2.8 G, 85/1,4 G, 16-35/4, 24-70/4, 28-70/3.5-5.6, 28/2.0 - SONY ZA 35/2.8, 35/1.4, 50/1.4, 50/1,8 55/1.8/ 10-18/4 - Zeiss Loxia 21/2.8, 35/2.0, 50/2.0
- 3** Battery chargers, cables
- 4** Accessories (baseplate, rods, top grip handles, lockports, cables, batteries, controllers, GoPro)
- 5** external recorder Atomos/Sound Device etc

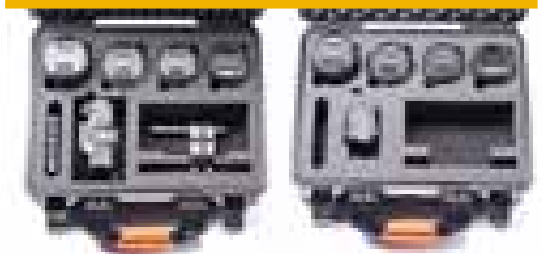

TECHNICAL FEATURES

Dimension:

internal dimension
409x306x175(mm) - 16.1x12.05x6.89(in)
external dimension
435x377,8x193(mm) - 17.13x14.87x7.60(in)

Weight:

empty: 2,57kg - 5.65lbs
with cubed foam: 2,97kg - 6.55lbs

Temperature rating:

Minimum Maximum
-40°C -40°F +80°C +176°F



TECHNICAL DRAWING

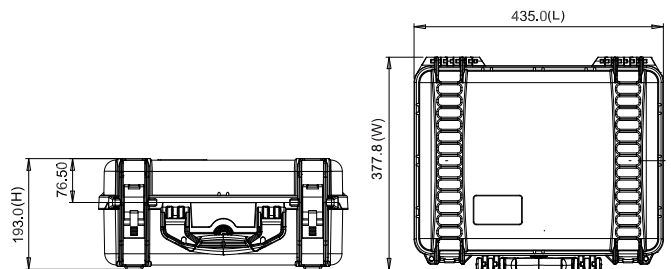

HPRC2400 for Sony FX3

FX3-2400-01

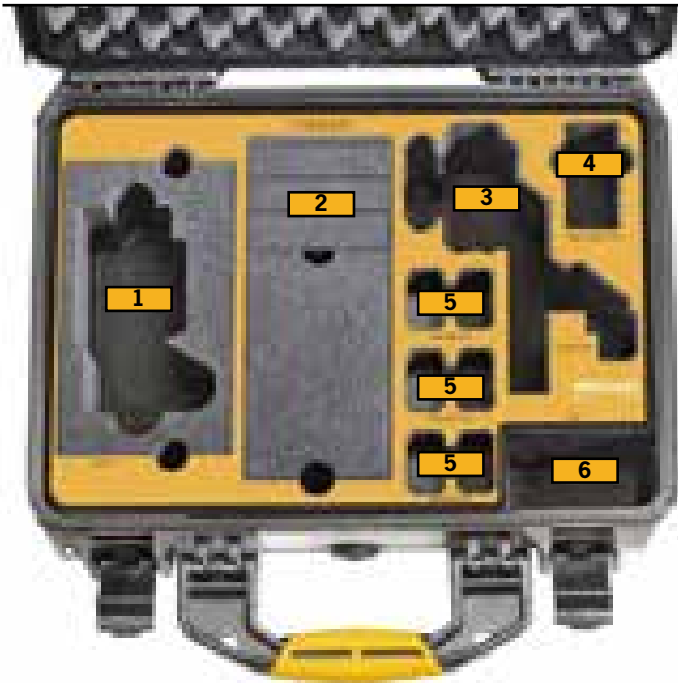

- 1** Sony FX3
- 2** Lenses: Diameter Max 90mm × Length Max 220mm
- 3** XLR Handle Unit
- 4** Battery Charger BC-QZ1
- 5** Battery NP-FZ100
- 6** Cable



HPRC SONY FX3

TECHNICAL FEATURES

Dimension:

Internal dimension
377x263,9x150,8(mm) - 14.84x10.39x5.94(in)
External dimension
402x330,5x169,2(mm) - 15.83x13.01x6.66(in)

Weight:

empty: 2,49kg - 5.48lbs
with cubed foam: 3,20kg - 7.04lbs

Temperature rating:

Minimum Maximum
-40°C -40°F +80°C +176°F



TECHNICAL DRAWING

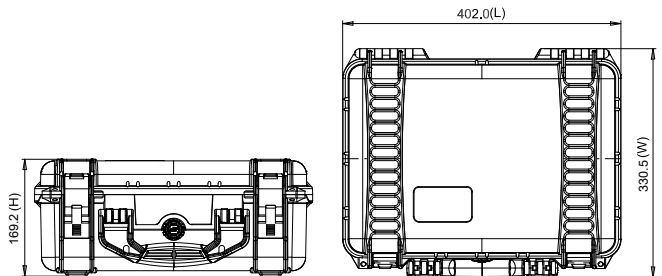

HPRC2550W for Sony ILME-FX6 FX6-2550W-01

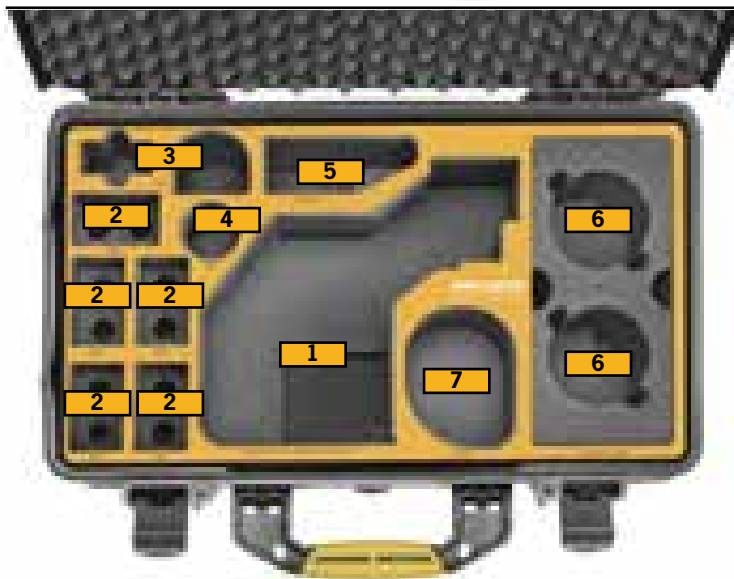

- 1** Sony ILME-FX6 Cinema Line + Smart Handle
- 2** BP-U35 or BP-U100 Battery
- 3** Charger
- 4** Cables
- 5** LCD Monitor 3,5"
- 6** 2x Lenses GM or x Tele GM
- 7** Smart Grip



HPRC SONY ILME-FX6

TECHNICAL FEATURES

Dimension:
 internal dimension
 513x288x200(mm) - 20.19x11.34x7.87(in)
 external dimension
 549x346x236(mm) - 21.61x13.62x9.29(in)

Weight:
 empty: 4,35kg - 9.57lbs
 with foam: 5,04kg - 11.10 lbs

Temperature rating:
 Minimum Maximum
 -40°C -40°F +80°C +176°F



TECHNICAL DRAWING

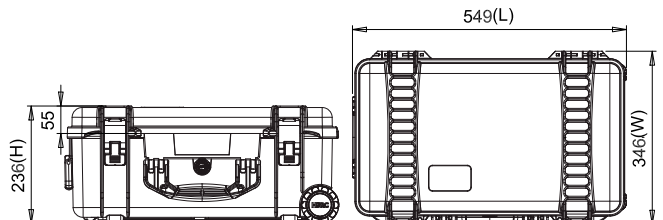

HPRC2700W for Sony PXW-FX9

FX9-2700W-01



SONY
PXW-FX9



- 1 Sony Camcorder
- 2 Viewfinder LCD
- 3 External Microphone
- 4 Battery Sony BP-U Series
- 5 Lens Adapter Metabones
- 6 Sony XQD/SD Card
- 7 Canon CNE Prime Lens
- 8 Cine Lenses up to 105mm Ø
- 9 Photo Lenses up to 105mm Ø
- 10 Hand Grip
- 11 Cable
- 12 Charger
- 13 HPRC1100 MEMBLB



TECHNICAL FEATURES

Dimension:

Internal dimension
554,7x458,7x246(mm) - 21.84x18.06x9.69(in)
External dimension
617,5x527,3x279,6(mm) - 24.31x20.76x11.0(in)

Weight:

empty: 7,75kg - 17.09lbs
with cubed foam: 9,07kg - 19.99lbs

Temperature rating:

Minimum Maximum
-40°C -40°F +80°C +176°F



TECHNICAL DRAWING

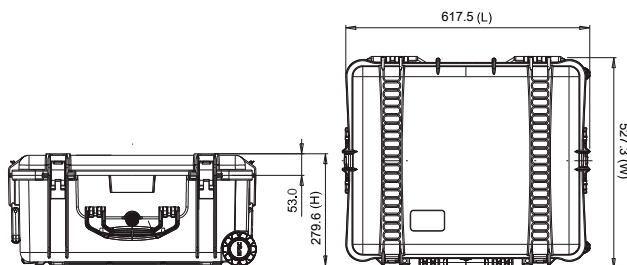

HPRC2730W for Sony Venice

VEN2730W-01



- 1** Sony Venice With Axs-R7 Mounted
- 2** Axs Memory And Sxs Memory Axs-Ar1
- 3** Lanparte Universal Grip Ug-02
- 4** Accessories/Air Evf Mount
- 5** Miscellaneous
- 6** Power Supply V-Lock Pc2l
- 7** Battery V-Lock B100usb/B230usb
- 8** Viewfinder Dvf-EI200
- 9** Hprc1300 Sxs
- 10** Shoulder Mount Accessory Vct-Fsa5
- 11** Tripod Place
- 12** Shoulder Mount Rods



TECHNICAL FEATURES

Dimension:

internal dimension
503x459x316(mm) - 19.80x18.07x12.44(in)
external dimension
616,9x531x349,6(mm) - 24.29x20.91x13.76(in)

Weight:

empty: 8,39kg - 18.49lbs
with cubed foam: 10,19kg - 22.47lbs

Temperature rating:

Minimum Maximum
-40°C -40°F +80°C +176°F



TECHNICAL DRAWING

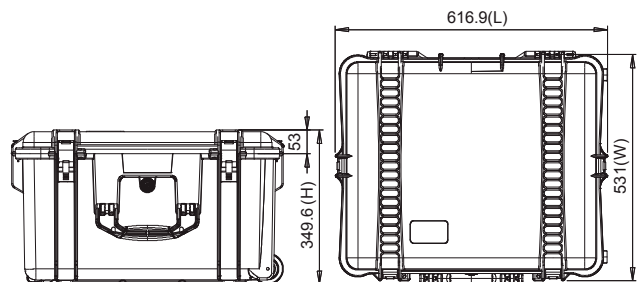

HPRC2600W for Sony PXW-Z280

Z280-2600W-01

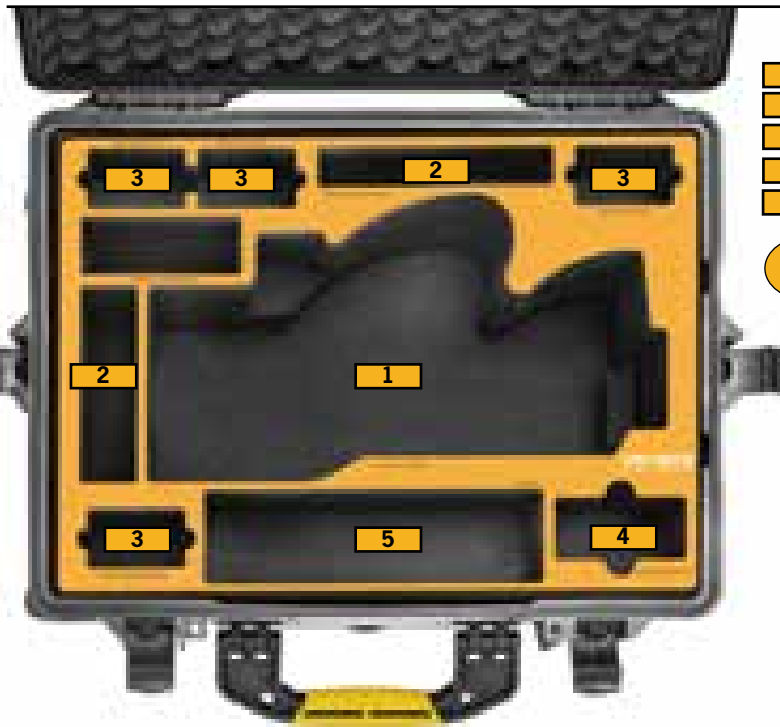

- 1** Sony Camcorder PXW-Z280
- 2** Cables/Accessories/Miscellaneous
- 3** Battery Sony BPU – U60
- 4** Compact 4K Wide Conversion
- 5** Microphone



HPRC SONY PXWZ280

TECHNICAL FEATURES

Dimension:

Internal dimension
482,4x358,3x217,6(mm) - 18.99x14.1x8.57(in)
External dimension
546,9x426,8x250,7(mm) - 21.53x16.8x9.87(in)

Weight:

empty: 6,05kg - 13.34lbs
with cubed foam: 6,97kg - 15.37lbs

Temperature rating:

Minimum Maximum
-40°C -40°F +80°C +176°F



TECHNICAL DRAWING

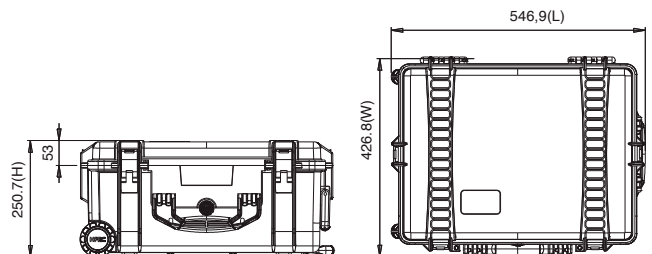

HPRC2700W for Sony PXW-Z190V

Z190-2700W-01



SONY
PXW-Z190V



- 1** Sony Camcorder PXW-Z190VC
- 2** BC-U1 battery charger
- 3** Battery Sony BPU \Swit S-8U63
- 4** Microphone
- 5** Wireless Audio Set Sony UWP-D11/K51PRO
- 6** Cables/Accessories/Miscellaneous



HPRC SONY PXWZ190V

TECHNICAL FEATURES

Dimension:

Internal dimension
554,7x458,7x246(mm) - 21.84x18.06x9.69(in)
External dimension
617,5x527,3x279,6(mm) - 24.31x20.76x11.0(in)

Weight:

empty: 7,75kg - 17.09lbs
with cubed foam: 9,07kg - 19.99lbs

Temperature rating:

Minimum Maximum
-40°C -40°F +80°C +176°F



TECHNICAL DRAWING

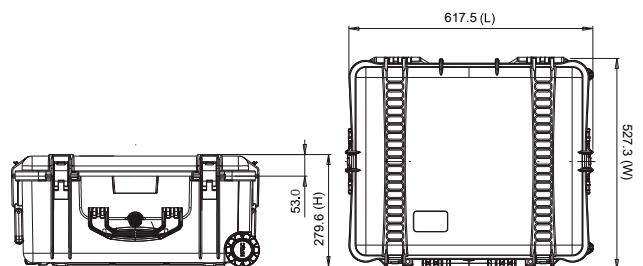



CANON

HPRC READY MADE SOLUTIONS – 2023

HPRC2300 for Canon Eos R5 / R6

CR5-2300-01



- 1** Canon EOS R5 / R6 Mirrorless Digital Camera (with or without professional cage)
- 2** Lenses: Diameter Max 90mm x Length Max 220mm
- 3** Cable/Miscellaneous
- 4** LC-E6 Charger for LP-E6 Battery Pack
- 5** LP-E6NH Lithium-Ion Battery (7.2V, 2130mAh)



TECHNICAL FEATURES

Dimension:

Internal dimension
305,7x232,4x137,5(mm) - 12.04x9.15x5.41(in)
External dimension
334,6x303x155,2(mm) - 13.17x11.93x6.11(in)



Weight:

empty: 1,75kg - 3.86lbs
with cubed foam: 1,90kg - 4.19lbs

Temperature rating:

Minimum Maximum
-40°C -40°F +80°C +176°F

TECHNICAL DRAWING

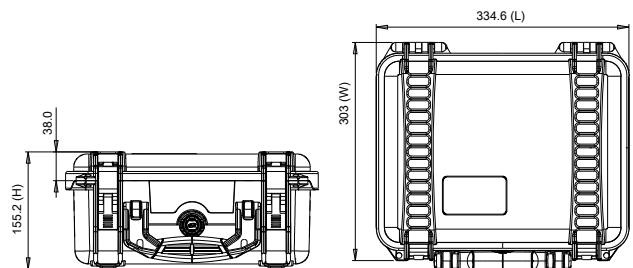

HPRC2700W for Canon Eos C300 Mark III

C300-2700W-01



- 1** EOS C300 Mark III Body
- 2** Lens CN-E18-80
- 3** Lens 110/90 mm diameter, depth 180mm
- 4** Monitor
- 5** Handle
- 6** Charger
- 7** Various/Cable
- 8** Battery BP-A30/BP-A60
- 9** Charger
- 10** HPRC1100MEM



TECHNICAL FEATURES

Dimension:

Internal dimension
554,7x458,7x246(mm) - 21.84x18.06x9.69(in)
External dimension
617,5x527,3x279,6(mm) - 24.31x20.76x11.0(in)

Weight:

empty: 7,75kg - 17.09lbs

Temperature rating:

Minimum	Maximum
-40°C -40°F	+80°C +176°F



TECHNICAL DRAWING

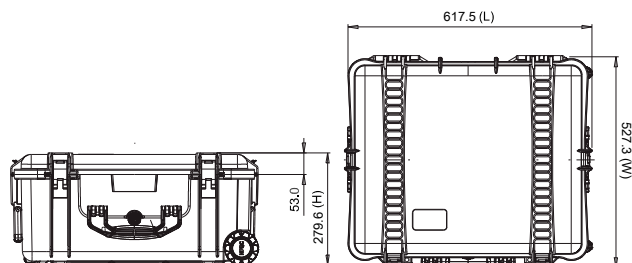

HPRC2600 for Canon Eos C70

C70-2600-01



- 1** Canon Eos C70
- 2** Batteries BP-A60/BP-A30
- 3** Lens Canon RF 24-105 or similar
- 4** Lens Canon RF 15-35 or similar
- 5** Lens Canon RF 70-200 or similar
- 6** Lens Canon RF 24-70 or similar
- 7** Canon Adapter EF-RF 0.71x
- 8** HPRC1300MEMBLB
- 9** CA-CP200L
- 10** Miscellaneous
- 11** Battery Charger CG-A20 OTH
- 12** Handle unit

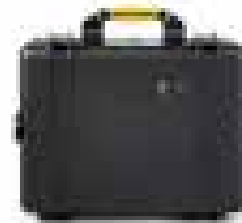

TECHNICAL FEATURES

Dimension:

internal dimension
482,4x358,3x198,1(mm) - 18.99x14.1x7.8(in)
external dimension
543,4x426,8x218,1(mm) - 21.39x16.8x8.59(in)

Weight:

empty: 4,25kg - 9.37lbs
with cubed foam: 5,05kg - 11.13lbs

Temperature rating:

Minimum Maximum
-40°C -40°F +80°C +176°F



TECHNICAL DRAWING

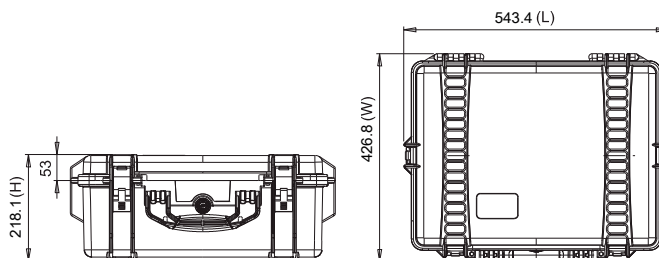

HPRC2600 for Canon Eos C200

C200-2600-01

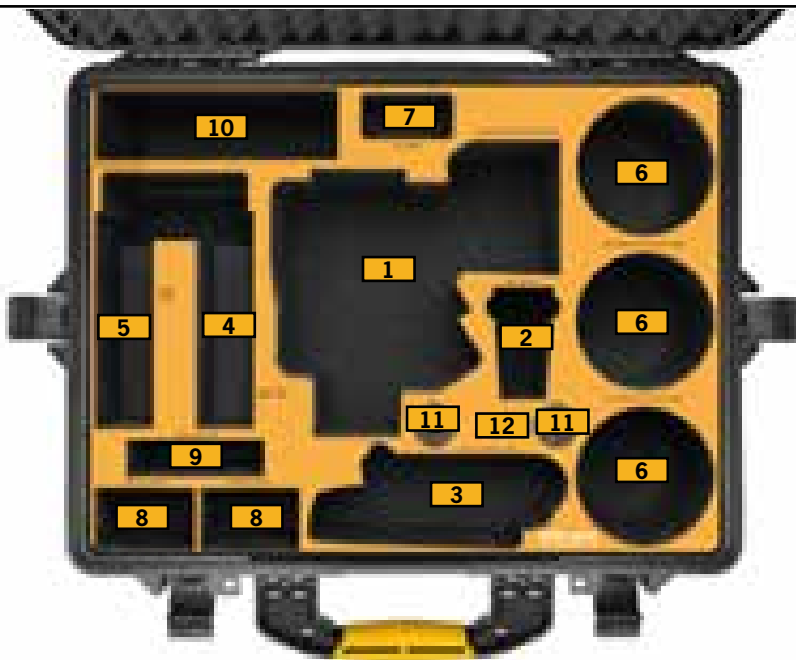

- 1** Canon Eos C200 With Camera Grip Mounted
- 2** Handle Unit Hdu-2
- 3** Monitor Lcd Lm-V1, Lcd La-V1
- 4** Compact Power Adaptor Ca-A10
- 5** Compact Adaptor Cp200b
- 6** Lenses Ef85mm/16-35/24-70/24-105Mm
- 7** HPRC1100MEM
- 8** Battery Pack A30/A60
- 9** Battery Charger A-20
- 10** Miscellaneous Accessories
- 11** Screw
- 12** Allen Key



TECHNICAL FEATURES

Dimension:

internal dimension
482,4x358,3x198,1(mm) - 18.99x14.1x7.8(in)
external dimension
543,4x426,8x218,1(mm) - 21.39x16.8x8.59(in)



Weight:

empty: 4,31kg - 9.50lbs
with cubed foam: 4,84kg - 10.663lbs

Temperature rating:

Minimum Maximum
-40°C -40°F +80°C +176°F

TECHNICAL DRAWING

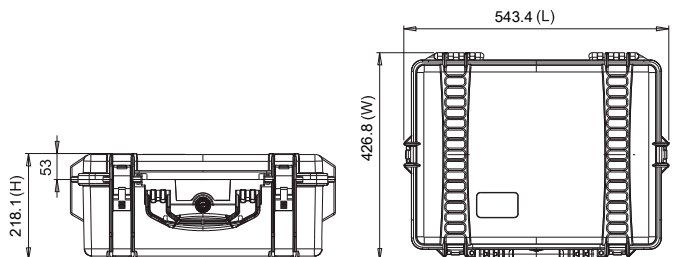

HPRC2600 for Canon Eos C100

C100-2600-01



- 1** Canon Eos C100 With Viewfinder and Camera Grip Mounted
- 2** Handle Unit
- 3** Lenses Ef85mm/16-35/24-70/24-105Mm
- 4** Battery Pack Bp 955
- 5** Battery Pack Bp 975
- 6** Battery Charger Cg-940
- 7** Compact Adaptor Ca-941
- 8** Miscellaneous Accessories
- 9** HPRC1100MEM



HPRC CANON EOS C100

TECHNICAL FEATURES

Dimension:

internal dimension
482,4x358,3x198,1(mm) - 18.99x14.1x7.8(in)
external dimension
543,4x426,8x218,1(mm) - 21.39x16.8x8.59(in)

Weight:

empty: 4,25kg - 9.37lbs
with cubed foam: 5,05kg - 11.13lbs

Temperature rating:

Minimum Maximum
-40°C -40°F +80°C +176°F



TECHNICAL DRAWING

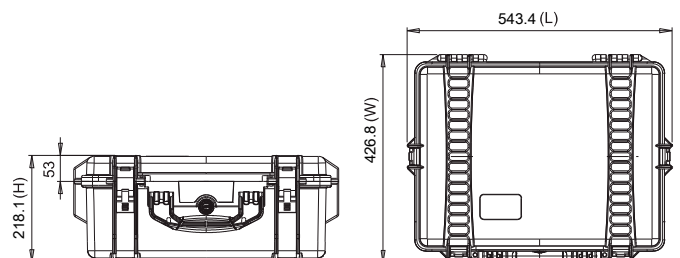



MATTEBOX

HPRC READY MADE SOLUTIONS – 2023

HPRC2600 for Tilta MB-T12 Mattebox

T12MB-2600-01

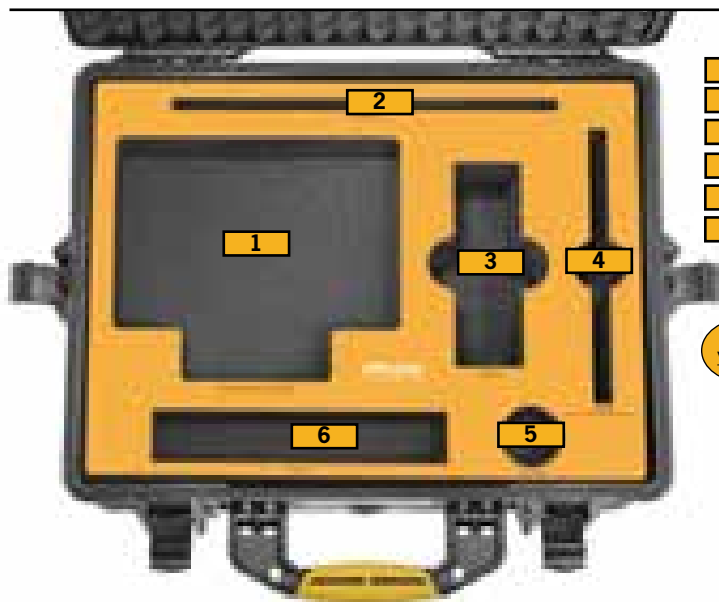

- 1** Carbon fiber body with 15mm LWS attached
- 2** Top French flag
- 3** Step-down rings
- 4** Hard Mattes (16-20mm, 24-28mm, 32-35mm, 50-85mm, 85-180mm)
- 5** Miscellaneous
- 6** Miscellaneous



HPRC TILTA MB-T12 MATTEBOX

TECHNICAL FEATURES

Dimension:

internal dimension
482,4x358,3x198,1(mm) - 18.99x14.1x7.8(in)
external dimension
543,4x426,8x218,1(mm) - 21.39x16.8x8.59(in)



Weight:

empty: 4,31kg - 9.50lbs
with cubed foam: 5,03kg - 11.09lbs

Temperature rating:

Minimum Maximum
-40°C -40°F +80°C +176°F

TECHNICAL DRAWING

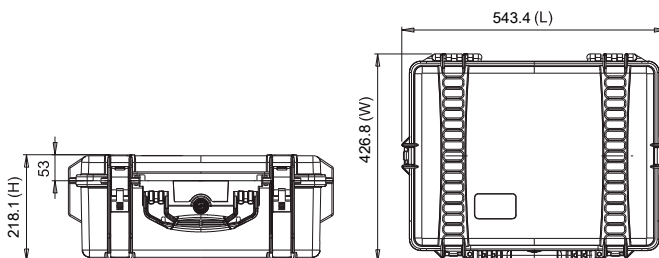



MOZA

HPRC READY MADE SOLUTIONS – 2023

HPRC2530 for Moza Air2 Ifocus

MAIR2-2530-01

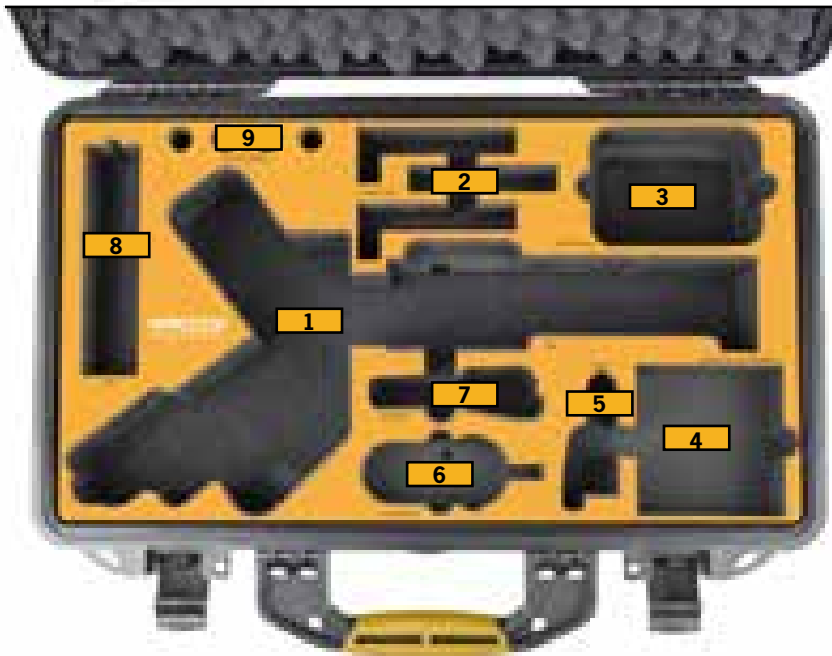
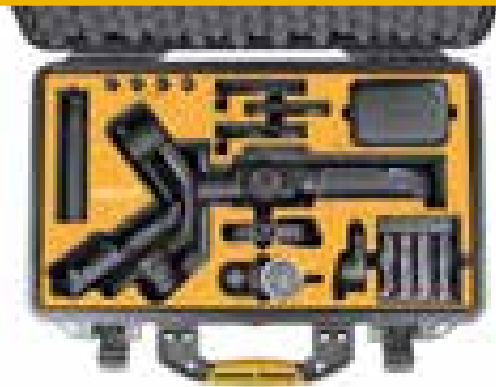

- 1 Gimbal
- 2 Quick Release Plate
- 3 Cable storage bag
- 4 Intelligent Charger and 18650 batteries
- 5 Ifocus M
- 6 Ifocus Handunit
- 7 Ifocus Motor
- 8 Tripod
- 9 Follow focus install pipe



TECHNICAL FEATURES

Dimension:
 internal dimension 513x288x132(mm) - 20.20x11.34x5.20(in)
 external dimension 540x350x153(mm) - 21.26x13.78x6.02(in)

Weight:
 empty: 3,20kg - 7.05lbs
 with cubed foam: 3,26kg - 7.19lbs

Temperature rating:
 Minimum -40°C -40°F Maximum +80°C +176°F



TECHNICAL DRAWING

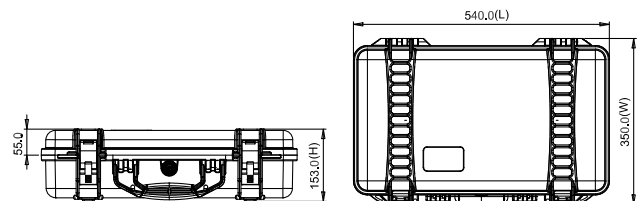



ZHIYUN CRANE

HPRC READY MADE SOLUTIONS – 2023



HPRC2700W for Zhiyun Crane 3S Pro

CR3SP-2700W-01

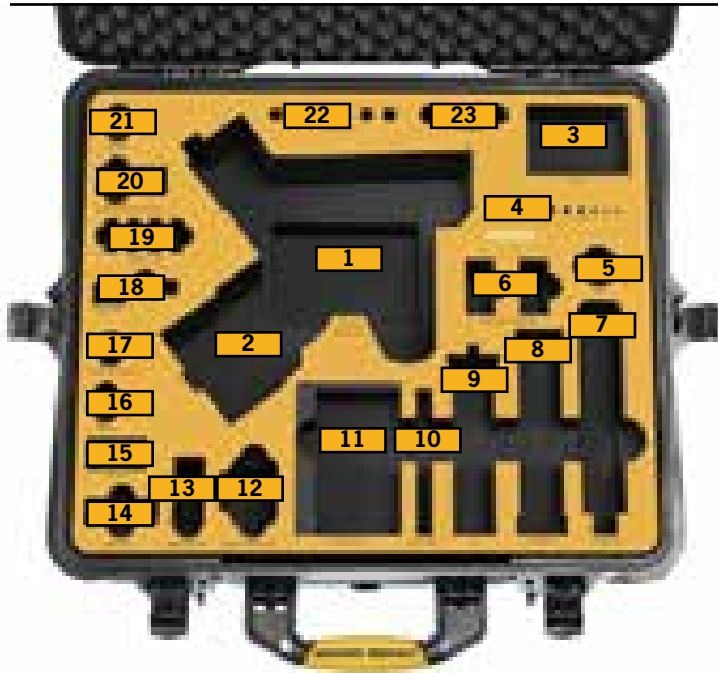

- 1** Crane 3S Gimbal
- 2** Various/Miscellaneous
- 3** Cables
- 4** Allen Keys
- 5** Charger
- 6** TransMount Servo Zoom/Focus Motor
- 7** SmartSling Handle
- 8** EasySling Handle
- 9** Tripod
- 10** Quick Release Plate
- 11** Various/Miscellaneous
- 12** TransMount PowerPlus Battery Pack
- 13** TransMount Phone Holder
- 14** Battery Charger
- 15** Lens Support
- 16** Extension Arm
- 17** SmartSling Handle Adapter Base
- 18** V-Lock Wedge Mount
- 19** Support for Lens Tube
- 20** TransMount Image Transmission Transmitter
- 21** Backing Base
- 22** Lens Support Tube
- 23** Li-ion Batteries



HPRC ZHIYUN CRANE 3S PRO

TECHNICAL FEATURES

Dimension:

Internal dimension
554,7x458,7x246(mm) - 21.84x18.06x9.69(in)
External dimension
617,5x527,3x279,6(mm) - 24.31x20.76x11.0(in)



Weight:

empty: 7,75kg - 17.09lbs
with cubed foam: 9,07kg - 19.99lbs

Temperature rating:

Minimum Maximum
-40°C -40°F +80°C +176°F

TECHNICAL DRAWING

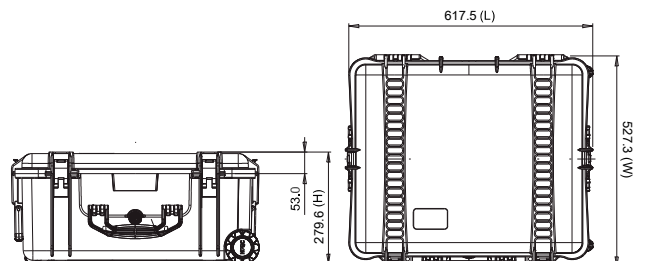

HPRC2700W for ZHIYUN Crane 3 Lab Master package CR3-2700W-01

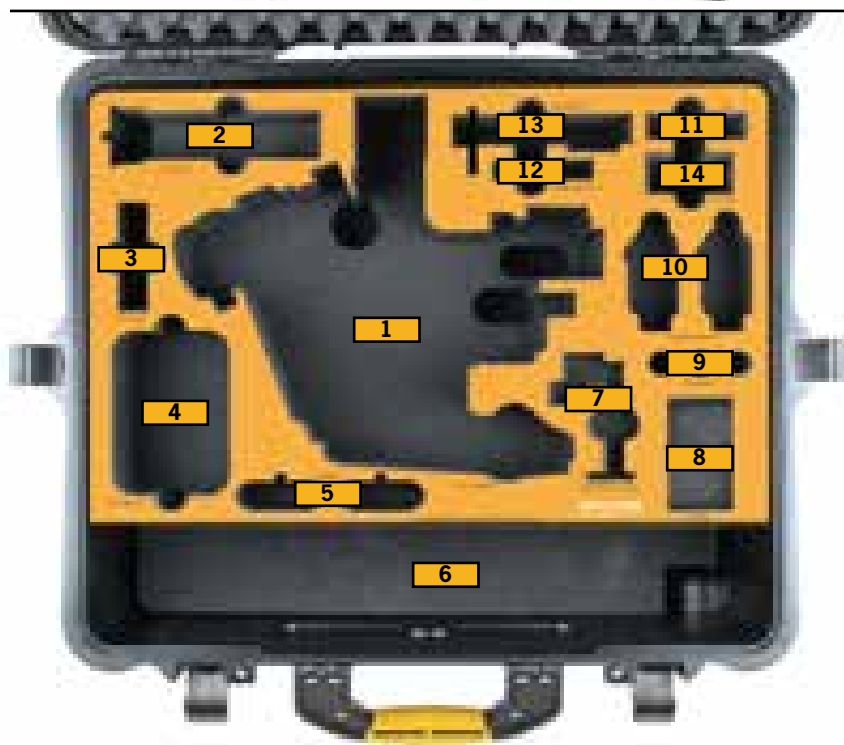

- 1 Crane 3 Lab Stabilizer
- 2 Handheld Tripod
- 3 Battery Charger
- 4 Cable Storage Case
- 5 Quick Setup Kits
- 6 Telescopic Monopod with Locking Buckle and Multifunctional Camera Belt
- 7 Phone Holder with Crown Gear
- 8 Miscellaneous
- 9 Batteries 18650
- 10 Focus and Zoom Combo Kits
- 11 Cable
- 12 Quick Release Base Plate
- 13 Quick Release Plate
- 14 HPRC1100 (not included)



HPRC ZHIYUN CRANE 3

TECHNICAL FEATURES

Dimension:

Internal dimension
554,7x458,7x246(mm) - 21.84x18.06x9.69(in)
External dimension
617,5x527,3x279,6(mm) - 24.31x20.76x11.0(in)

Weight:

empty: 7,74kg - 17.06lbs
with cubed foam: 8,84kg - 19.49lbs

Temperature rating:

Minimum Maximum
-40°C -40°F +80°C +176°F



TECHNICAL DRAWING

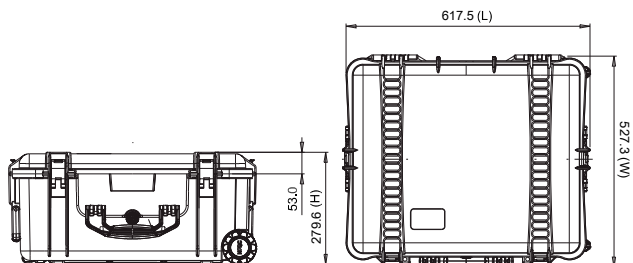

HPRC2600W for ZHIYUN Crane 3 Lab

CR3-2600W-01



- 1** Crane 3 Lab Stabilizer
- 2** TransMount Handheld Tripod
- 3** Battery Charger
- 4** Batteries 18650
- 5** Cable Storage Case
- 6** Quick Release Plate
- 7** TransMount Phone Holder



HPRC ZHIYUN CRANE 3 LAB

TECHNICAL FEATURES

Dimension:

Internal dimension
482,4x358,3x217,6(mm) - 18.99x14.1x8.57(in)

External dimension
546,9x426,8x250,7(mm) - 21.53x16.8x9.87(in)

Weight:

empty: 6,05kg - 13.34lbs
with cubed foam: 6,97kg - 15.37lbs

Temperature rating:

Minimum Maximum
-40°C -40°F +80°C +176°F



TECHNICAL DRAWING

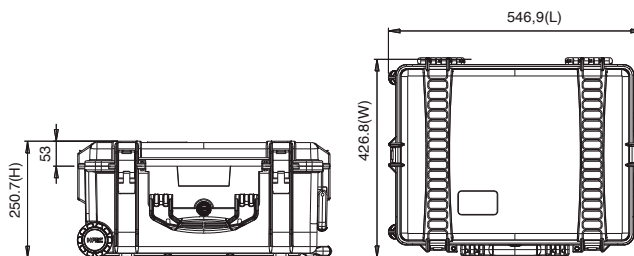



Z CAM

HPRC READY MADE SOLUTIONS – 2023

HPRC2400 for Z CAM E2-F6 Full Frame 6K Cinema Camera ZE2F6-2400-01



- 1** Z CAM E2-F6 Full Frame 6K Cinema Camera with SmallRig Cage mounted
- 2** Alternative Lens Mount
- 3** Accessories
- 4** Charger
- 5** Cable
- 6** NF-P Battery
- 7** CFAST 2.0
- 8** WiFi Antenna



HPRC Z CAM E2-F6

TECHNICAL FEATURES

Dimension:

Internal dimension
377x263,9x150,8(mm) - 14.84x10.39x5.94(in)
External dimension
402x330,5x169,2(mm) - 15.83x13.01x6.66(in)

Weight:

empty: 2,23kg - 4.91lbs
with cubed foam: 2,49kg - 5.49lbs

Temperature rating:

Minimum Maximum
-40°C -40°F +80°C +176°F



TECHNICAL DRAWING

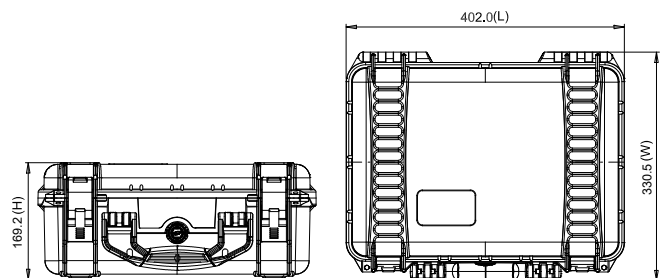



CHASING-INNOVATION

HPRC READY MADE SOLUTIONS – 2023

HPRC2710 for Chasing Innovation

Gladius Mini Rev. 2

GLA2710-02



GLADIUS MINI



- 1** Chasing Innovation Gladius Mini
- 2** Remote Controller
- 3** Winder & Tether
- 4** Power Adapter
- 5** Cable



HPRC GLADIUS MINI

TECHNICAL FEATURES

Dimension:

Internal dimension
555x459x256(mm) - 21.85x18.07x10.08(in)
External dimension
617x525x280(mm) - 24.29x20.67x11.02(in)



Weight:

empty: 6,71kg - 14.76lbs

Temperature rating:

Minimum Maximum
-40°C -40°F +80°C +176°F

TECHNICAL DRAWING

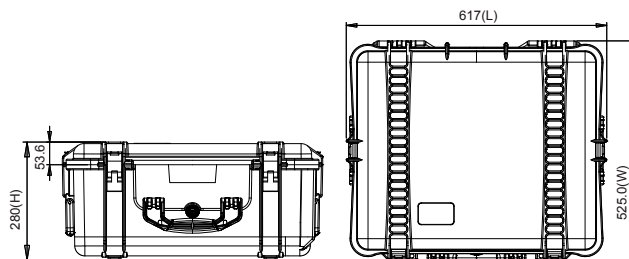



HPRC 2500

FUJIFILM

HPRC READY MADE SOLUTIONS - 2023

HPRC2500 for Fujifilm GFX100

GFX100-2500-01



- 1** Fujifilm GFX100
- 2** Cable storage/Miscellaneous
- 3** Adjustable lens: FUJIFILM GF 110mm f/2 R LM WR Lens, 23mm f/4 R LM WR Lens, 45mm f/2.8 R WR Lens, 32-64mm f/4 R LM WR Lens
- 4** Battery charger
- 5** Battery NP-T125
- 6** Ac Power Adapter



HPRC FUJIFILM GFX100

TECHNICAL FEATURES

Dimension:

internal dimension
449,8x322,9x174,9(mm) - 17.71x12.71x6.89(in)
external dimension
478,1x389,4x194(mm) - 18.82x15.33x7.64(in)

Weight:

empty: 3,22kg - 7.10lbs
with cubed foam: 3,75kg - 8.27lbs

Temperature rating:

Minimum Maximum
-40°C -40°F +80°C +176°F



TECHNICAL DRAWING

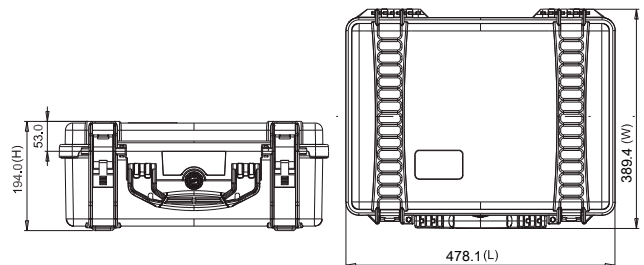



RED

HPRC READY MADE SOLUTIONS - 2023

HPRC2730W for Red Ranger Gemini

RGE-2730W-01

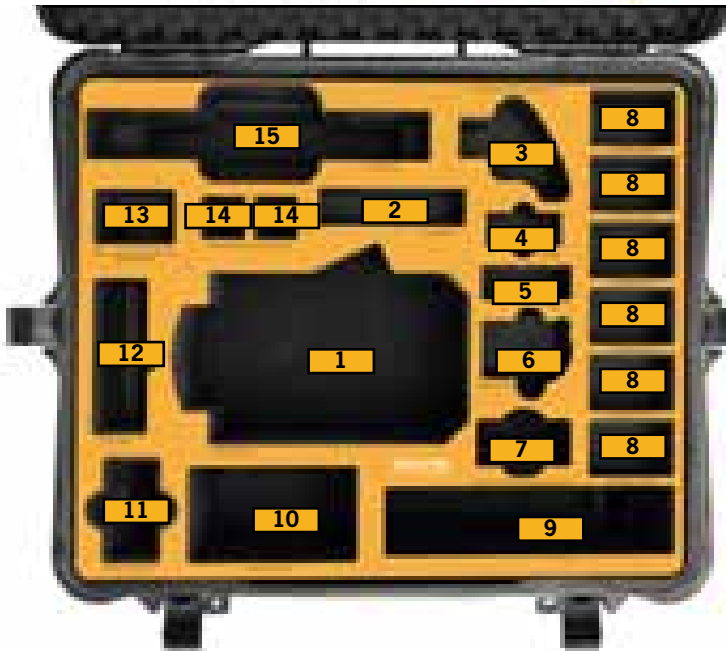

- 1** Camera with Top Handle
- 2** HPRC1300 MEVBLB
- 3** Right Side Wooden Handle 2.0 with R/S Button - Tilta
- 4** Red Mini Mag
- 5** Cable
- 6** Red Bomb EVF DSMC
- 7** Titan Support Arm with Single 1/4" QR Bracket – Monitor Side
- 8** GDU 98Wh Mini V-Lock Battery
- 9** Cable
- 10** BlueShape Travel Charger
- 11** Red Ranger Ac Power Adaptor
- 12** DSMC2 Red Touch 7.0" LCD
- 13** Smallrig for monitor LCD EVF Mount/BMVA/SmallHD, Zacuto Gratical HD1938
- 14** Smallrig Rosette Arm Handle for Shoulder Stabilizer
- 15** Quick Release Platform



HPRC RED RANGER GEMINI

TECHNICAL FEATURES

Dimension:

internal dimension
503x459x316(mm) - 19.80x18.07x12.44(in)
external dimension
616,9x531x349,6(mm) - 24.29x20.91x13.76(in)

Weight:

empty: 8,41kg - 18.54lbs
with cubed foam: 10,43kg - 22.99lbs

Temperature rating:

Minimum Maximum
-40°C -40°F +80°C +176°F



TECHNICAL DRAWING

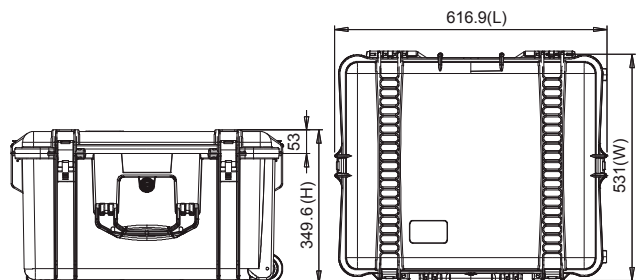



NIKON

HPRC READY MADE SOLUTIONS – 2023

HPRC2460 for Nikon D850

D850-2460-01



for **NIKON D850**



- 1** D850 Camera Body
- 2** Additional EN-EL15a Rechargeable Li-ion Battery
- 3** ME-W1 Wireless Microphone
- 4** ME-1 Stereo Microphone
- 5** Atomos Ninja Flame
- 6** Lenses: AF-S NIKKOR 35mm f/1,8G ED / AF-S NIKKOR 85mm f/1.8G / AF-S NIKKOR 20mm f/1,8G ED
- 7** MH-25A Battery Charger/ UC-E22 USB Cable / Coiled HDMI Cable

HPRC NIKON D850

TECHNICAL FEATURES

Dimension:

internal dimension
409x306x175(mm) - 16.1x12.05x6.89(in)
external dimension
435x377,8x193(mm) - 17.13x14.87x7.60(in)

Weight:

empty: 2,55kg - 5.62lbs
with cubed foam: 3,14kg - 6.92lbs

Temperature rating:

Minimum Maximum
-40°C -40°F +80°C +176°F



TECHNICAL DRAWING

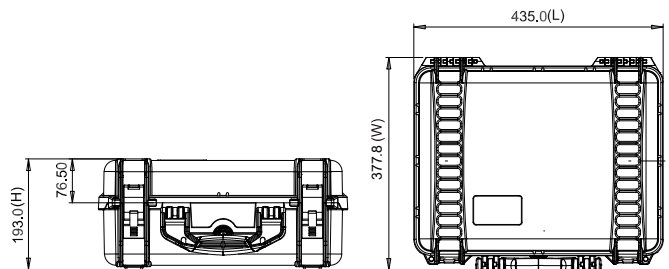



PANASONIC

HPRC READY MADE SOLUTIONS – 2023

HPRC2460 for Panasonic GH5 GH52460-01

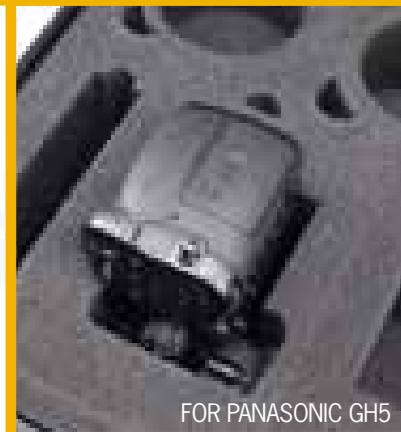

HPRC2460 for PANASONIC GH5 is a special edition, designed to safely carry your GH5 Lumix G Series.



- 1** PANASONIC GH5 with or without professional cage and lenses mounted
- 2** Lenses: lumix g 8mm f3,5 (fisheye) hd, lumix dg summilux 12 f1.4, lumix g pancake 14mm f2.5, leica dg summilux 15mm / f1,7 asph, lumix g 20mm f1,7 (asph), leica dg summilux 25mm f1,4 (asph), lumix g 25mm f1.7 asph., lumix g 30mm macro f2,8, leica dg noctricron 42,5 mm f 1,2 (asph) hd, lumix g dg 1,7 / 42,5mm asph/power o.i.s., leica dg macro-elmarit 45mm f2,8 (asph), lumix g vario 7-14mm f4,0 (asph) hd, leica dg vario elmarit 8-18, lumix g x vario 12-32mm f3.5-f5.6 (asph) hd, lumix g x vario 12-35mm f2,8 (asph) hd, lumix g x vario 12-35 ii, leica dg vario elmarit 12-60, lumix g vario 12-60, lumix g vario 14-42mm f3,5-5,6 (asph) hd, lumix g vario 14-42mm f3,5-5,6 (asph) hd, lumix g x vario pz 14-42mm f3,5-5,6 (asph), lumix g vario 14-42mm f3,5-5,6 (asph) hd, lumix g x vario pz 14-42mm f3,5-5,6 (asph), lumix g x vario 35-100mm f2,8 hd, lumix g x vario 35-100 ii, lumix g vario 35-100mm f4,0-5,6, lumix g vario 45-200 ii, lumix g 12,5mm f12,5 3d
- 3** Battery chargers, cables
- 4** Accessories (baseplate, rods, top grip handles, lockports, cables, batteries, controllers, GoPro)
- 5** External recorder Atomos/Sound Device etc

HPRC PANASONIC GH5

TECHNICAL FEATURES

Dimension:

internal dimension
409x306x175(mm) - 16.1x12.05x6.89(in)
external dimension
435x377,8x193(mm) - 17.13x14.87x7.60(in)

Weight:

empty: 2,55kg - 5.62lbs
with cubed foam: 3,14kg - 6.92lbs

Temperature rating:

Minimum Maximum
-40°C -40°F +80°C +176°F



TECHNICAL DRAWING

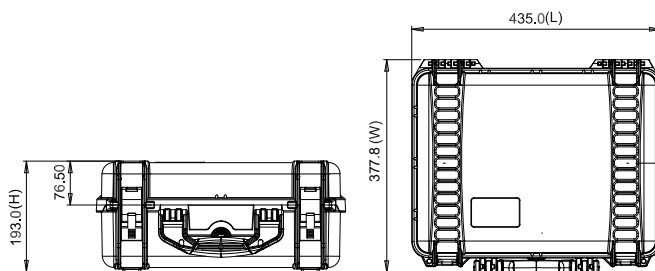



LEICA



LEICA



HPRC READY MADE SOLUTIONS - 2023

HPRC2400 for Leica M

LEM2400-01



FOR LEICA M



- 1** 1 x Leica M Camera Body with Lens Attached
- 2** Electronic Viewfinder
- 3** 4 x Lens
- 4** Charger
- 5** Spare Battery
- 6** Cables/Miscellaneous

TECHNICAL FEATURES

Dimension:

Internal dimension
377x263,9x150,8(mm) - 14,84x10,39x5,94(in)
External dimension
402x330,5x169,2(mm) - 15,83x13,01x6,66(in)

Weight:

empty: 2,38kg - 5,25lbs

Temperature rating:

Minimum Maximum
-40°C -40°F +80°C +176°F



TECHNICAL DRAWING

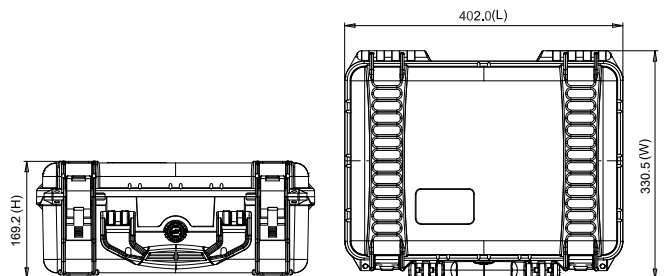

HPRC2460 for Leica M LEM2460-01



FOR LEICA M



- 1** 2 x Leica M Camera Body with Lens Attached
- 2** 2 x Electronic Viewfinder
- 3** 2 x Spare Batteries
- 4** 4 x Lens
- 5** 2 x Charger
- 6** Cables/Miscellaneous



HPRC LEICA M

TECHNICAL FEATURES

Dimension:

internal dimension
409x306x175(mm) - 16.1x12.05x6.89(in)
external dimension
435x377,8x193(mm) - 17.13x14.87x7.60(in)

Weight:

empty: 2,55kg - 5.62lbs
with cubed foam: 3,14kg - 6.92lbs

Temperature rating:

Minimum Maximum
-40°C -40°F +80°C +176°F



TECHNICAL DRAWING

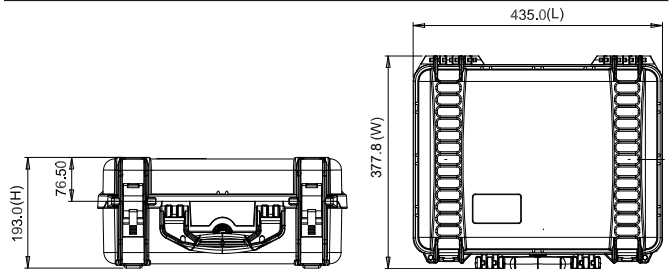



8
11
16
MP
20





APPLE



HPRC READY MADE SOLUTIONS - 2023

HPRC2530 for Apple Mac Studio / Mac Mini

STU-2530-01

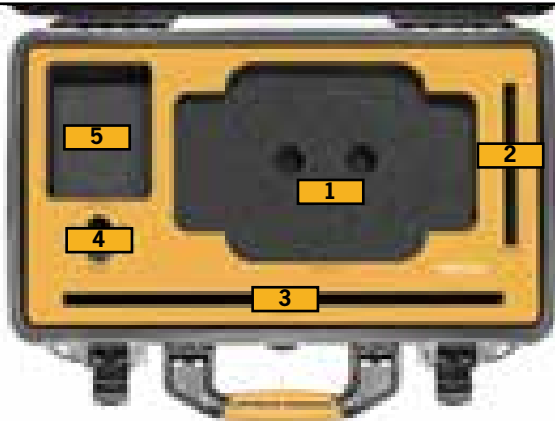

- 1** Mac Studio / Mac Mini
- 2** Magic Trackpad
- 3** Magic Keyboard
- 4** Magic Mouse
- 5** Cable/Miscellaneous



MAC STUDIO LAYOUT

Just remove the additional foam **2** from the main slot **1**.
The case is ready to house and protect your Mac Studio.



MAC MINI LAYOUT

Keep the additional foam **2** in the main slot **1**.
Your Mac Mini can be placed above. Safe and sound.

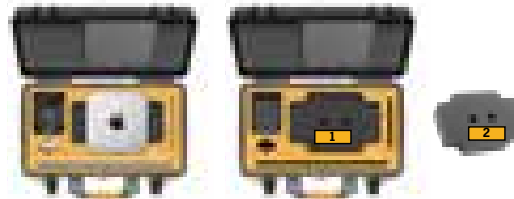

TECHNICAL FEATURES

Dimension:

Internal dimension:
513x288x132(mm) - 20.20x11.34x5.20(in)
External dimension:
540x350x153(mm) - 21.26x13.78x6.02(in)

Weight:

empty: 3,20kg - 7,05lbs
with cubed foam: 3,26kg - 7.19lbs

Temperature rating:

Minimum Maximum
-40°C -40°F +80°C +176°F



TECHNICAL DRAWING

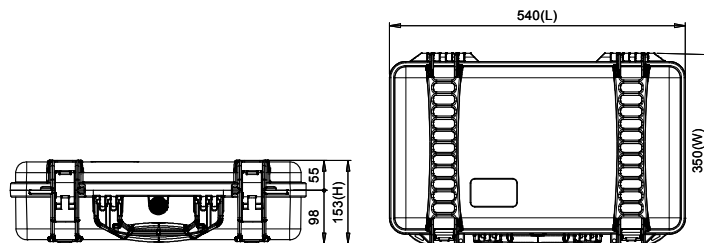

HPRC2530 for MacBook Pro 16'

MPRO-2530-01



- 1** MacBook Pro 16"
- 2** Miscellaneous



HPRC APPLE MACBOOK PRO 16"

TECHNICAL FEATURES

Dimension:

Internal dimension
51.3x28.8x1.32(mm) - 20.20x11.34x0.52(in)
External dimension
54.0x35.0x1.53(mm) - 21.26x13.78x0.60(in)

Weight:

empty: 2,84kg - 6.26lbs
with foam: 3,25kg - 7.16lbs

Temperature rating:

Minimum Maximum
-40°C -40°F +80°C +176°F



TECHNICAL DRAWING

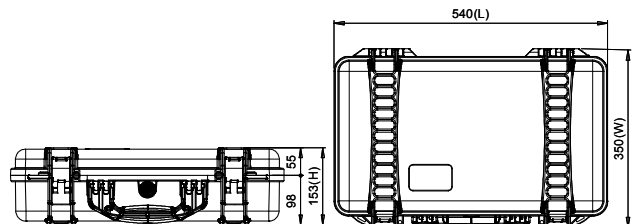

HPRC4800W for Apple Mac Pro

MPRO-4800W-01

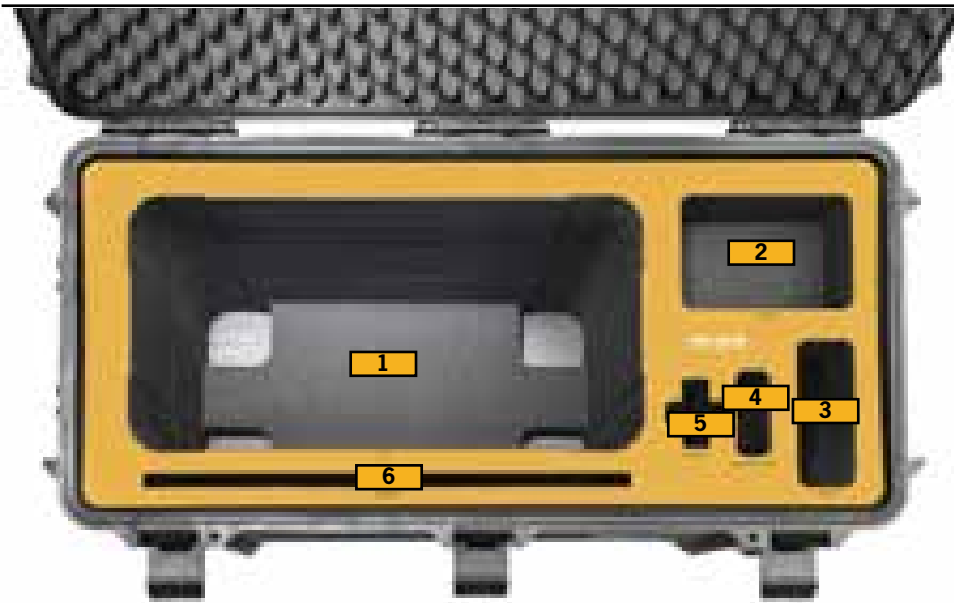

- 1** Mac Pro
- 2** Miscellaneous
- 3** Power cord
- 4** USB-C to Lightning Cable
- 5** Magic Mouse 2
- 6** Magic Keyboard



HPRC APPLE MAC PRO 2020

TECHNICAL FEATURES

Dimension:

internal dimension
720x320x600(mm) - 28.34x12.60x23.62(in)
external dimension
776x380x649(mm) - 30.55x14.96x25.55(in)



Weight:

empty: 10,00kg - 22.21lbs
with cubed foam: 14,10kg - 31.08lbs

Temperature rating:

Minimum Maximum
-40°C -40°F +80°C +176°F

TECHNICAL DRAWING

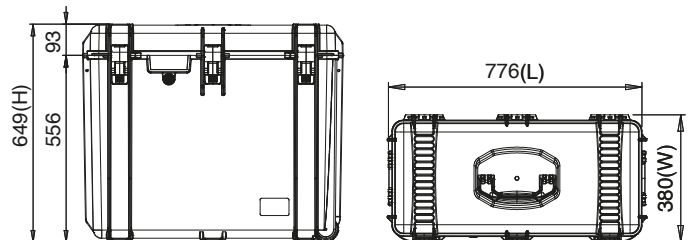

HPRC2400 for MacPro15"

MPRO-2400-01



- 1** MacBook Pro 15"
- 2** Miscellaneous



HPRC APPLE MACPRO 15"

TECHNICAL FEATURES

Dimension:

Internal dimension
377x263,9x150,8(mm) - 14.84x10.39x5.94(in)
External dimension
402x330,5x169,2(mm) - 15.83x13.01x6.66(in)

Weight:

empty: 2,38kg - 5.25lbs

Temperature rating:

Minimum Maximum
-40°C -40°F +80°C +176°F



TECHNICAL DRAWING

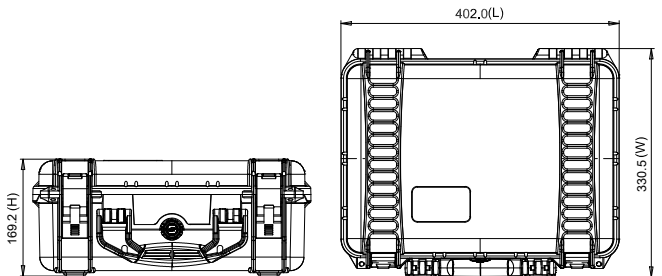



 READY



EIZO

HPC READY MADE SOLUTIONS – 2023

HPRC4800W for EIZO 27/24" EIZ27-4800W-01

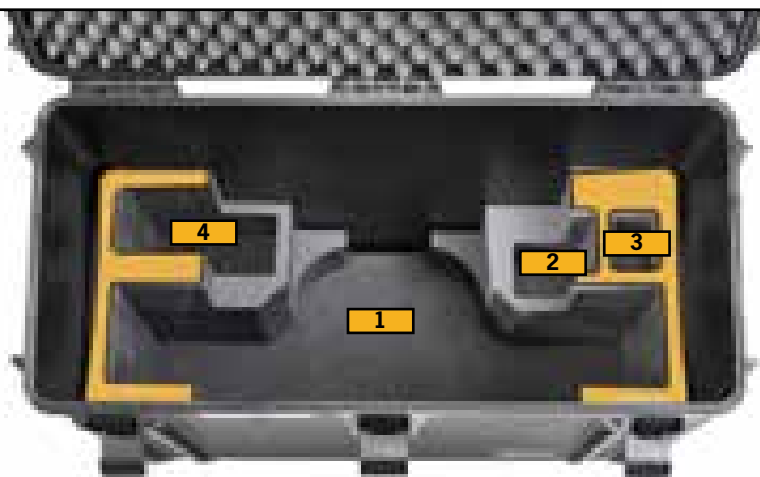
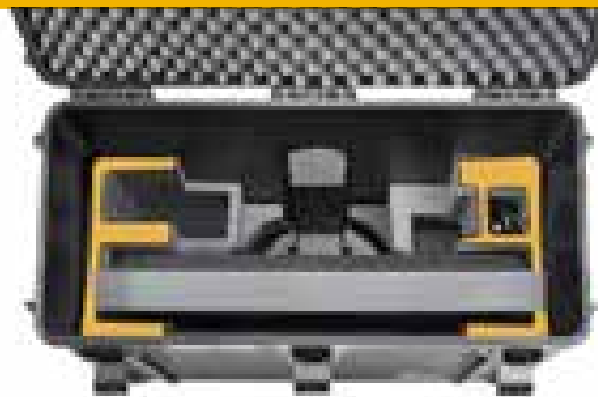

- 1** Eizo Monitor 27" or 24"
- 2** Cables and accessories
- 3** Cables and accessories
- 4** Protective hood and accessories



HPRC EIZO 27/24"

TECHNICAL FEATURES

Dimension:

internal dimension
720x320x600(mm) - 28.34x12.60x23.62(in)
external dimension
776x380x649(mm) - 30.55x14.96x25.55(in)



W

Weight:

empty: 11,12kg - 24.50lbs
with cubed foam: 12,43kg - 27.40lbs

Temperature rating:

Minimum Maximum
-40°C -40°F +80°C +176°F

TECHNICAL DRAWING

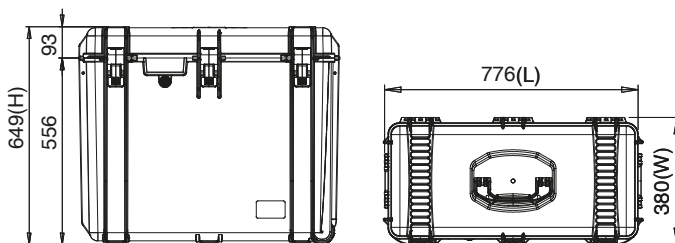



UNIVERSAL MICROPHONES

HPRC READY MADE SOLUTIONS – 2023

HPRC2200 for Universal Microphones

MCF3-2200-01



1 Universal Microphone



TECHNICAL FEATURES

Dimension:

internal dimension
236x182x108(mm) - 9.29x7.17x4.25(in)
external dimension
258x244,3x123,3(mm) - 10.16x9.62x4.85(in)

Weight:

empty: 0,87kg - 1.92lbs
with cubed foam: 1,08kg - 2.38lbs

Temperature rating:

Minimum Maximum
-40°C -40°F +80°C +176°F



TECHNICAL DRAWING

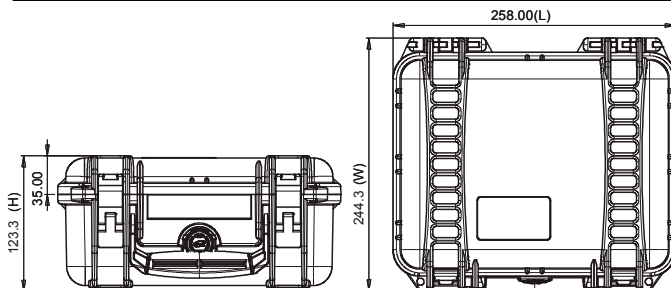

HPRC2250 for Universal Microphones

MCF6-2250-01



LEVEL 1

LEVEL 2

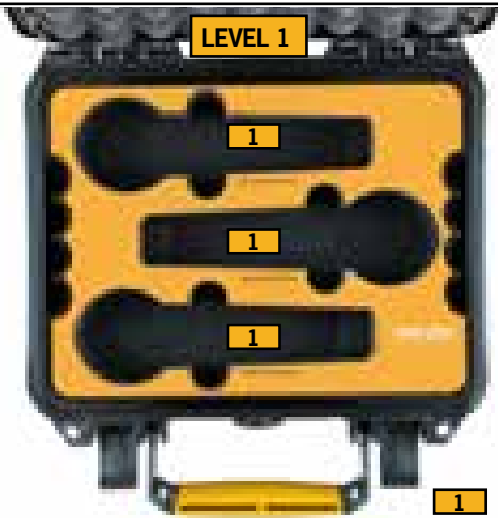

LEVEL 1



LEVEL 2

1 Universal Microphone



HPRC MICROPHONES

TECHNICAL FEATURES

Dimension:

internal dimension
236x182x155(mm) - 9.29x7.17x6.10(in)
external dimension
258X230X170(mm) - 10.16x9.06x6.69(in)

Weight:

empty: 1,00kg - 2.20lbs
with cubed foam: 1,35kg - 2.97lbs

Temperature rating:

Minimum Maximum
-40°C -40°F +80°C +176°F



TECHNICAL DRAWING

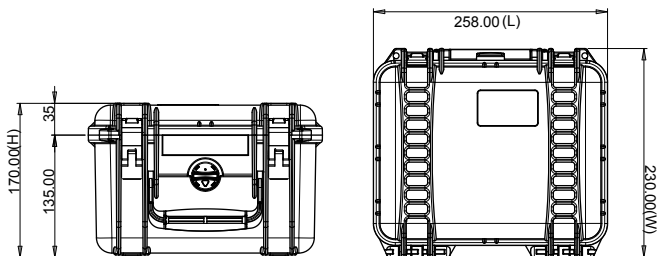



I



BROMPTON

BROMPTON

HPRC READY MADE SOLUTIONS – 2023

HPRC4800W for Brompton BRO4800W-01

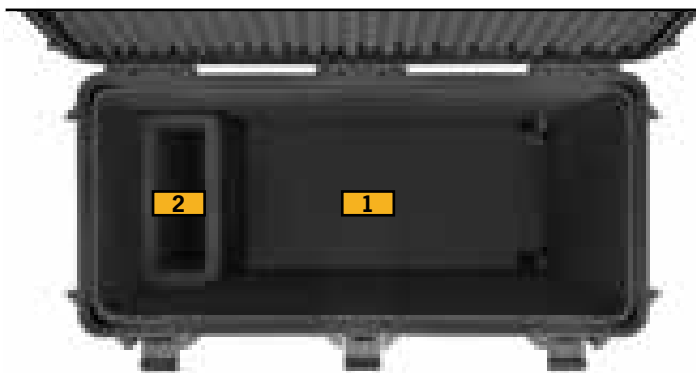

1 Brompton Bike

2 Accessories



HPRC BROMPTON

TECHNICAL FEATURES

Dimension:

internal dimension
720x320x600(mm) - 28.34x12.60x23.62(in)
external dimension
776x380x649(mm) - 30.55x14.96x25.55(in)

Weight:

empty: 10,00kg - 22.21lbs
with cubed foam: 14,10kg - 31.08lbs

Temperature rating:

Minimum Maximum
-40°C -40°F +80°C +176°F



TECHNICAL DRAWING

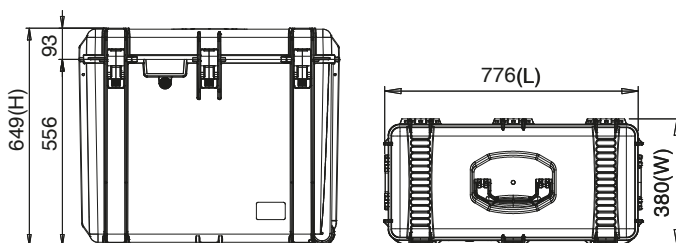

Index

code	description	page
	DJI	4
MAV3-2400-01	HPRC2400 FOR DJI MAVIC 3 CINE / DJI MAVIC 3 / DJI MAVIC 3 CLASSIC	5
MAV3-3500-01	HPRC3500 FOR DJI MAVIC 3 CINE / DJI MAVIC 3 / DJI MAVIC 3 CLASSIC	6
MAVBAG35-05	SOFT BAG WITH FOAM FOR DJI MAVIC3 CINE OR DJI MAVIC3	7
PHA4RTK-2700W-01	HPRC2700W FOR DJI PHANTOM 4RTK / MULTISPECTRAL	8
DRTK6500W-01	HPRC6500W FOR DJI D-RTK2	9
M30T-5200R-01	HPRC5200R FOR MATRICE 30T	10
M30T-2760W-01	HPRC2760W FOR MATRICE 30T	11
M30T-2700W-01	HPRC2700W FOR MATRICE 30T	12
BAT2460-01	HPRC2460 FOR BATTERIES TB30 AND DJI RC PLUS	13
M300-2800W-03	HPRC2800W FOR DJI MATRICE 300 RTK	14
BAT2550W-04	HPRC2550W BATTERY CASE FOR DJI MATRICE 300	15
MAVM2300-03-01	HPRC2300 FOR DJI MINI 3 PRO / DJI MINI 3 FLY MORE COMBO WITH RC AND RC-N1 CONTROLLER	16
MAV2A-2400-02	HPRC2400 FOR DJI AIR 2S AND MAVIC AIR 2 REV.02	17
MAV2A-2300-02	HPRC2300 FOR DJI AIR 2S AND MAVIC AIR 2 FLY MORE COMBO	18
MAV2A-3500-01	HPRC3500 FOR DJI AIR 2S AND MAVIC AIR 2 FLY MORE COMBO	19
MAVBAG35-04	HPRC SOFT BACKPACK FOR DJI AIR 2S AND MAVIC AIR 2 FLY MORE COMBO	20
AVAT-2500-01	HPRC2500 FOR DJI AVATA PRO - VIEW COMBO	21
AVAT-3500-01	HPRC3500 FOR DJI AVATA PRO - VIEW COMBO	22
FPV-2500-01	HPRC2500 FOR DJI FPV COMBO	23
FPV-3600-01	HPRC3600 FOR DJI FPV COMBO	24
PHA4-2710-02	HPRC2710 FOR DJI PHANTOM 4	25
PHA4-BAG27-02	SOFT BAG FOR DJI PHANTOM 4	26
INS2-2780W-02	HPRC2780W FOR DJI INSPIRE 2	27
M600-2800W-01	HPRC2800W PER DJI MATRICE 600 // MATRICE 600 PRO	29
M210-4600W-04	HPRC4600W FOR DJI MATRICE 200 OR 210 - 2 X CENDENCE CONTROLLERS/ CRYSTALSKY	30
R4D-2730W-01	HPRC2730W FOR DJI RONIN 4D-6K COMBO	31
SCE-2300-01	HPRC2300 FOR DJI SMART CONTROLLER ENTERPRISE	32
ACT2-1400-01	HPRC 1400 FOR DJI ACTION 2 DUAL-SCREEN COMBO	33
OSMPKT-1400-02	HPRC 1400 FOR DJI POCKET 2 CREATIVE COMBO KIT	34
RS3-2600-01	HPRC2600 FOR DJI RS 3 PRO COMBO	35
RS2-2500-01	HPRC2500 FOR DJI RS 2 PRO COMBO	36
RS2-3500-01	HPRC3500 FOR DJI RS 2 PRO COMBO	37
RS2-BAG35-01	SOFT BAG FOR DJI RS 2 PRO COMBO	38
RSC2-2500-01	HPRC2500 FOR DJI RSC2 PRO COMBO	39
	AUTEL ROBOTICS	40
LITE-2460-01	HPRC2460 FOR FOR AUTEL ROBOTICS EVO LITE+ PREMIUM BUNDLE	41
NANO-2300-01	HPRC2300 FOR AUTEL ROBOTICS EVO NANO+ PREMIUM BUNDLE	42
EVO2-2400-02	HPRC2400 FOR AUTEL EVO II 6K / 8K DRONE - REV. 02	43
		44

code	description	page
	ATOMOS	45
NJAV-2300-01	HPRC2300 FOR ATOMOS NINJA V	46
SHG7-2400-01	HPRC2400 FOR ATOMOS SHOGUN 7" + ACCESSORY KIT	47
SM19-2730W-01	HPRC2730W FOR ATOMOS SUMO 19"	48
	BLACKMAGIC	49
PKT6P-2400-01	HPRC2400 FOR BLACKMAGIC POCKET CINEMA CAMERA 6K PRO	50
PKTC-2400-01	HPRC2400 COMBO FOR BLACKMAGIC POCKET CINEMA CAMERA 6K OR 4K + METABONES	51
AMI-2300-01	HPRC2300 FOR ATEM MINI, ATEM MINI PRO AND ATEM MINI PRO ISO	52
AME-2500-01	HPRC2500 FOR ATEM MINI EXTREME AND ATEM MINI EXTREME ISO	53
ADV1-2710-01	HPRC2710 FOR BLACKMAGIC DESIGN ATEM 1 M/E ADVANCED PANEL	54
URS2730W-03	HPRC2730W FOR BLACKMAGIC URSA MINI PRO - URSA BROADCAST	56
	SONY	57
ALP2460-01	HPRC2460 SPECIAL EDITION FOR SONY ALPHA	58
FX3-2400-01	HPRC2400 FOR SONY FX3 CINEMA LINE	59
FX6-2550W-01	HPRC2550W PER SONY ILME-FX6 CINEMA LINE	60
FX9-2700W-01	HPRC2700W FOR SONY PXW-FX9 - CINEMA LINE	61
VEN2730W-01	HPRC2730W FOR SONY VENICE - CINEMA LINE	62
Z280-2600W-01	HPRC2600W FOR SONY PXW-Z280	63
Z190-2700W-01	HPRC2700W FOR SONY PXWZ190V	64
	CANON	65
CR5-2300-01	HPRC2300 FOR CANON EOS R5 / R6	66
C300-2700W-01	HPRC2700W FOR CANON EOS C300 MARK III	67
C70-2600-01	HPRC2600 FOR CANON EOS C70	68
C200-2600-01	HPRC2600 FOR CANON EOS C200	69
C100-2600-01	HPRC2600 FOR CANON EOS C100	70
	MATTEBOX	71
T12MB-2600-01	HPRC2600 FOR TILTA MB-T12 MATTEBOX	72
	MOZA	73
MAIR2-2530-01	HPRC2530 FOR MOZA AIR2 IFOCUS	74
	ZHIYUN CRANE	75
CR3SP-2700W-01	HPRC2700W FOR ZHIYUN CRANE 3S PRO	76
CR3-2700W-01	HPRC2700W FOR ZHIYUN CRANE 3 LAB MASTER PACKAGE	77
CR3-2600W-01	HPRC2600W FOR ZHIYUN CRANE 3 LAB	78
	Z CAM	79
ZE2F6-2400-01	HPRC2400 FOR ZCAM E2-F6 FULL FRAME 6K CINEMA CAMERA	80
	CHASING-INNOVATION	81
GLA2710-02	HPRC2710 FOR CHASING INNOVATION GLADIUS MINI REV.02	82
	FUJIFILM	83
GFX100-2500-01	HPRC2500 FOR FUJIFILM GFX100	84

Index

code	description	page
	RED	85
RGE-2730W-01	HPRC2730W FOR RED RANGER GEMINI	86
	NIKON	87
D850-2460-01	HPRC2460 FOR NIKON D850 FILMMAKER'S KIT	88
	PANASONIC	89
GH52460-01	HPRC2460 SPECIAL EDITION FOR PANASONIC GH5 AND ACCESSORIES	90
	LEICA	91
LEM2400-01	HPRC2400 FOR LEICA M	92
LEM2460-01	HPRC2460 FOR LEICA M	94
	APPLE	95
STU-2530-01	HPRC2530 FOR APPLE MAC STUDIO / MAC MINI	96
MPRO-2530-01	HPRC2530 FOR MACBOOK PRO 16"	97
MPRO-4800W-01	HPRC4800W FOR APPLE MACPRO 2020	98
MPRO-2400-01	HPRC2400 FOR APPLE MACBOOK PRO 15"	100
	EIZO	101
EIZ27-4800W-01	HPRC4800W PER MONITOR EIZO 27"E MONITOR EIZO 24"	102
	UNIVERSAL MICROPHONES	104
MCF3-2200-01	HPRC2200 FOR 3 UNIVERSAL MICROPHONES	105
MCF6-2250-01	HPRC2250 FOR 6 UNIVERSAL MICROPHONES	106
	BROMPTON	107
BRO4800W-01	HPRC4800W FOR BROMPTON FOLDING BIKE	

 READY





Plaber S.r.l. - HPRC cases

Via Div. Tridentina, 10
36061 Bassano del Grappa
Vicenza - Italy

Tel. +39 0424 809150

USA office and warehouse:

Plaber America Inc - HPRC cases

110 Chestnut Ridge Rd. #314
Montvale, NJ 07645

Tel. +1 (201) 989 3353

www.hprc.it | www.hprcusa.com

info@hprc.it

HPRC® Brand owned by:

plaber

HPRC READY MADE SOLUTIONS — 2023